

# TC600/TC800

*Electronic total station*

*Version 2.1*

*English*

**TC600**

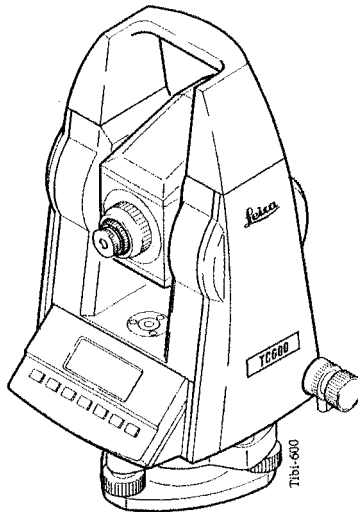

**TC800**

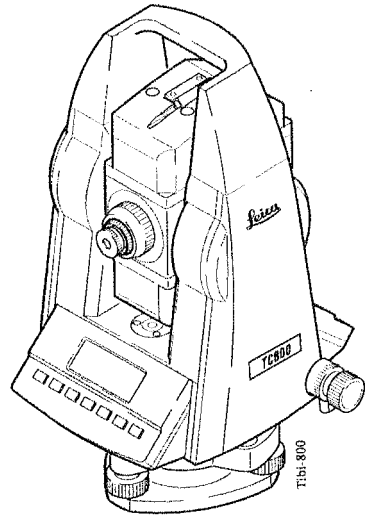

**SURVEYORS-EXPRESS™**



**Milanweg 53 • 61118 Bad Vilbel**

**Tel. 06101 / 54 13 54 • Fax 55**

**www.vermessen.de**

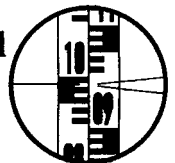





**Thank you for purchasing this Leica Total Station.**



This manual contains important safety directions (*refer to section "Safety directions"*) as well as instructions for setting up the instrument and operating it. Please read carefully through the User Manual to achieve maximum satisfaction.

# ***TC600/TC800***

## ***Electronic total station***

### ***Product identification***

The instrument model and the serial number of your product are indicated on the label in the battery compartment.

Write the model and serial number of your instrument in the space provided below, and always quote this information when you need to contact your agency or service workshop.

Type: \_\_\_\_\_ Serial no.: \_\_\_\_\_

---

## ***Symbols used in this Manual***

The symbols used in this User Manual have the following meanings:



**DANGER:**

Indicates an imminently hazardous situation which, if not avoided, will result in death or serious injury.



**WARNING:**

Indicates a potentially hazardous situation or an unintended use which, if not avoided, could result in death or serious injury.



**CAUTION:**

Indicates a potentially hazardous situation or an unintended use which, if not avoided, may result in minor or moderate injury and / or appreciable material, financial and environmental damage.



Important paragraphs which must be adhered to in practice as they enable the product to be used in a technically correct and efficient manner.

# Contents

<b>Introduction</b>	<b>8</b>
Area of applicability of this User's Manual	8
Important parts	9
<b>Set-up, getting started</b>	<b>11</b>
Unpacking	11
Charging battery	13
Set-up	14
Tribrach with optical plummet	14
Tribrach without optical plummet	15
Level instrument with the electronic level	16
<b>Operating concept</b>	<b>17</b>
Settings, first steps	17
Units in this manual	17
Display and keyboard	18
Menu tree (Main menu)	20
Menu tree (Configuration)	21
Main menu	22
<b>Measure and record</b>	<b>23</b>
Display symbols	23
Pointing and distance measurement	24
Example: for offset or hidden points	25
Display of recorded data	26
<b>Measure and record with coding</b>	<b>27</b>
<b>Coding</b>	<b>28</b>
Input a new code line to the code list	28
Simple code input during measurements	30
Using predefined codes from the codelist	31
Additional entries to selected code	32
<b>User Programs</b>	<b>34</b>
Introduction	34
Set Job	35
Set station coordinates (Station Coord)	36
Manual point entry (Keyb)	37
Read the station coordinates from internal memory (IntMem)	38
Orientation (of horizontal circle)	39
Free Station	41

Setting out (Setout)	46
Tie Distance (Missing line)	48
Area computation (Calc Area)	51
Rapid measurement and recording (Rapid Meas)	54
<b>Settings (SET)</b>	<b>57</b>
Entering point number and reflector height (SET Ptnr/hr)	57
Alphanumeric entry of point number	58
Entering reflector height	58
Setting the horizontal circle (Hz)	59
1st variant	59
2nd variant	60
Setting the display mask (DSP)	61
Display-masks	61
<b>Data management (DATA MANAGER)</b>	<b>62</b>
Coordinate entry (COORDS)	63
Input of coordinates and codes (INPUT)	63
Code input (CODES)	64
Searching for point numbers and multiple recordings (FIND)	65
Searching for several data blocks with the same point number	66
Display of stored data (VIEW)	67
Delete measurements, coordinates and codes (DELETE PNT)	68
Delete the complete range of measurements, coordinates and codes (DELETE ALL)	69
EDM mode	70
<b>EDM Configuration (EDM CONF)</b>	<b>70</b>
EGL (Guide Light)	71
INTENS	72
RETTAP	73
<b>Testing the instrument</b>	<b>75</b>
Battery and instrument temperature	75
EDM Signal	76
<b>Configuration</b>	<b>77</b>
Distance corrections	77
Meteorological correction (ppm)	77
Prism constant (MM)	78
Determine instrument errors	79
Vertical index error (V-Index "i")	79
Line-of-sight error (Hz-Collimation "c")	81



Contrast	82
Data and recording parameter (REC DATA)	83
Selecting units (UNITS)	86
Units for distance measurement (DIST)	86
Units for angle measurement (ANGLE)	86
V-Angle	87
Display number of decimal places (ROUND)	87
Automatic switch-off (ON/OFF)	88
<b>TCTOOLS</b>	<b>91</b>
<b>Other data formats</b>	<b>97</b>
<b>Communication PC-TC600/TC800</b>	<b>98</b>
Set station coordinates	98
Set orientation	98
Setting-out	99
<b>Checking and adjusting</b>	<b>100</b>
Tripod	100
Circular level	100
Circular level on the tribrach	101
Optical plummet	102
<b>Care and transport</b>	<b>104</b>
<b>Battery charging</b>	<b>106</b>
Battery chargers GKL22 and GKL23	106
Battery chargers GKL12 and GKL14	107
<b>Safety directions</b>	<b>108</b>
Intended use of instrument	108
Limits of use	109
Responsibilities	110
Hazards of use	111
Laser classification	116
Integrated distancer (EDM)	116
Guide Light EGL1	118
Electromagnetic acceptability	120
FCC statement (applicable in U.S.)	121
Product labeling	122
<b>Error reports and warnings</b>	<b>123</b>
<b>Technical data</b>	<b>125</b>
<b>Index</b>	<b>131</b>

---

## ***Introduction***

The TC600/TC800 is particularly suitable for cadastral and engineering surveying. The accuracy of angle-measuring, and the range of its EDM module, are matched to one another. The measured data can be stored in the internal memory or can be output individually via serial interface to an external recorder.

---

### ***Area of applicability of this User's Manual***

This manual applies to the following types of total stations:

- TC600
- TC800

Differences between the two versions are clearly set out and assigned.

General text applies to both versions.

**Important parts**

**TC600**

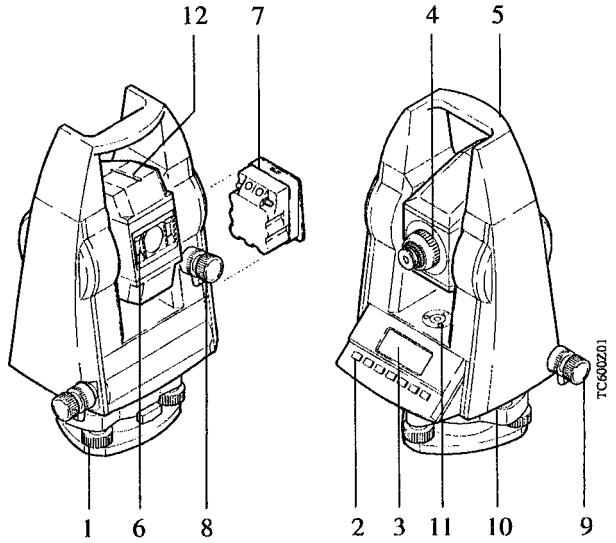

- |                   |                          |
|-------------------|--------------------------|
| 1 Foot screw      | 7 Battery                |
| 2 Keyboard        | 8 Vertical drive screw   |
| 3 Display         | 9 Horizontal drive screw |
| 4 Focusing        | 10 Interface RS-232      |
| 5 Carrying handle | 11 Circular level        |
| 6 Exit EDM        | 12 Optical sight         |

# TC800

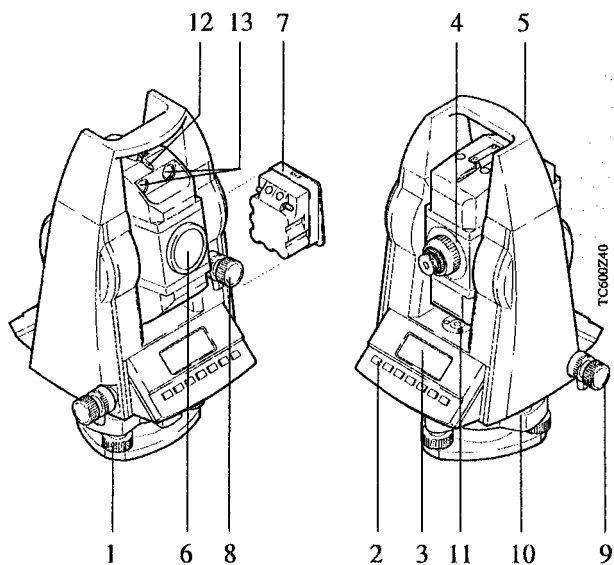

- |   |                 |    |                        |
|---|-----------------|----|------------------------|
| 1 | Foot screw      | 8  | Vertical drive screw   |
| 2 | Keyboard        | 9  | Horizontal drive screw |
| 3 | Display         | 10 | Interface RS-232       |
| 4 | Focusing        | 11 | Circular level         |
| 5 | Carrying handle | 12 | Optical sight          |
| 6 | Exit EDM        | 13 | Exit EGL1 (optional)   |
| 7 | Battery         |    |                        |

# Set-up, getting started

## Unpacking

Remove TC600/TC800 from transport case and check for completeness:

### TC600

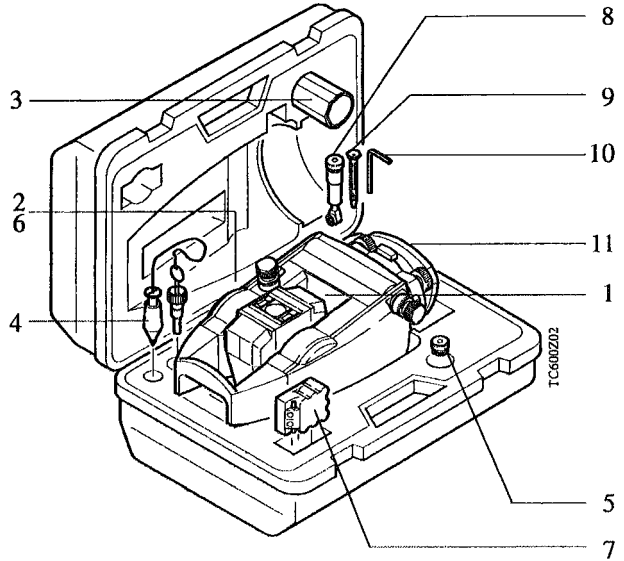

- |                         |  |
|-------------------------|--|
| 1 Instrument            | 7 Spare battery (optional)             |
| 2 User's Manual         | 8 Eyepiece for steep angles (optional) |
| 3 Protective cover      | 9 Screwdriver, set of pins             |
| 4 Plummet (optional)    | 10 Allen key                           |
| 5 Eyepiece (optional)   | 11 Tribrach (optional)                 |
| 6 Diskette with TCTOOLS |  |

# TC800

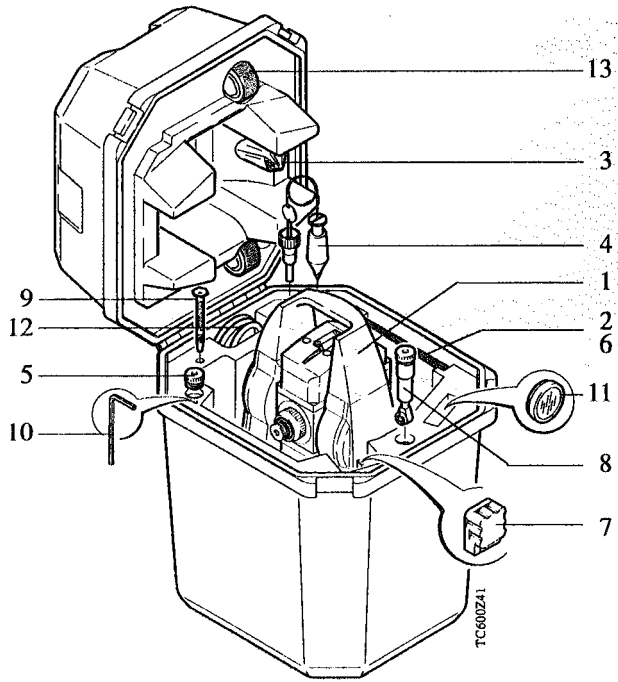

- |                            |  |
|----------------------------|--|
| 1 Instrument               | 8 Eyepiece for steep angles (optional) |
| 2 User's Manual            | 9 Screwdriver, set of pins             |
| 3 Protective cover         | 10 Allen key                           |
| 4 Plummet (optional)       | 11 Lens (optional)                     |
| 5 Eyepiece (optional)      | 12 Cable (optional)                    |
| 6 Diskette with TCTOOLS    | 13 Shoulder straps                     |
| 7 Spare battery (optional) |  |

## Charging battery

Charge batteries using GKL12, GKL14, GKL22 or GKL23. For more information about charging batteries refer to chapter "Battery charging".

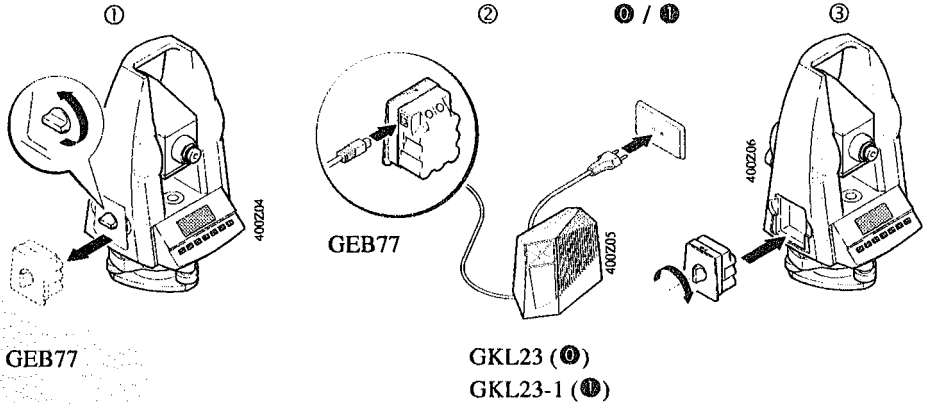

- ⓐ Version for 230V mains
- ⓑ Version for 115V mains

### Charging time:

Internal battery:	GEB77	1.0 hours
External batteries:	GEB70	1.5 hours
	GEB71	5.0 hours

(Refer also to chapter "Technical Data")



### WARNING:

The battery chargers are intended for indoor use. Only use a battery charger in a dry place, never outdoors.

# Set-up

## Tribrach with optical plummet

Set-up TC600/TC800  
with tribrach GDF 22 and  
tripod GST20

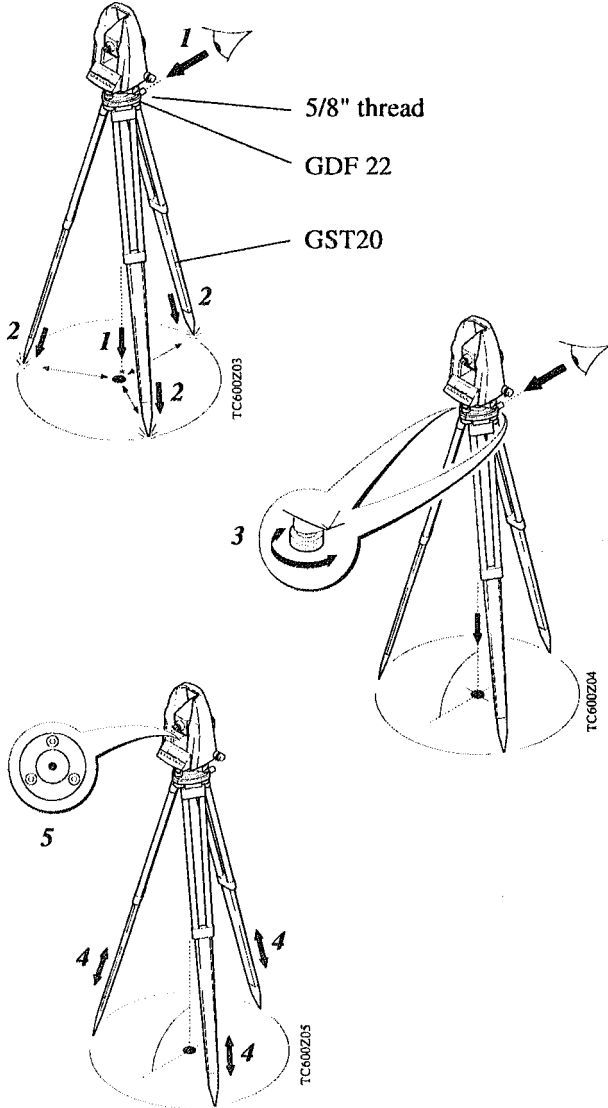
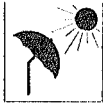



**Tribrach without optical plummet**

Set-up TC600/TC800  
with tribrach GDF 21 and  
tripod GST20

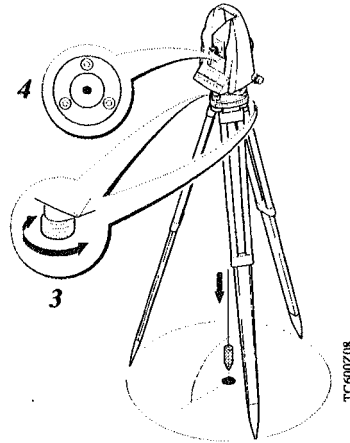
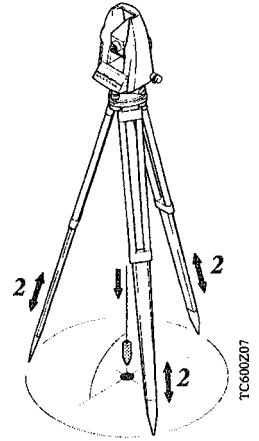
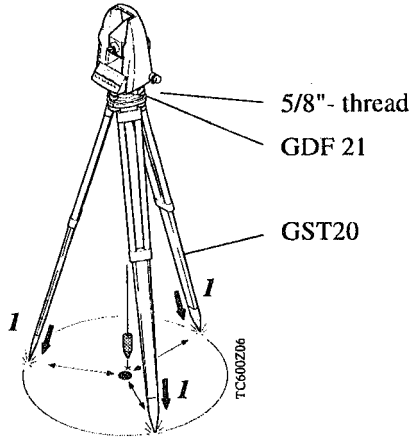

**Level instrument with  
the electronic level**

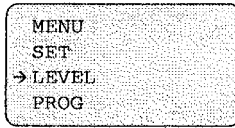
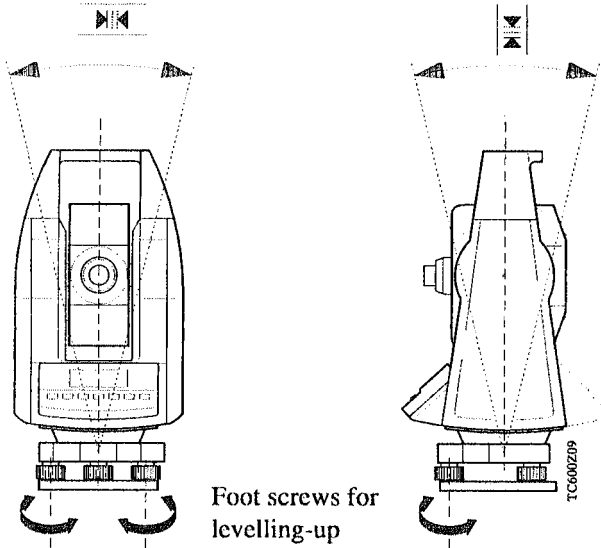

Insufficient levelling-up

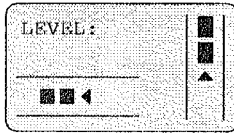

Perfect levelling-up



The TC600/TC800 unit is correctly levelled-up when the triangles are visible only or markers are displayed between the triangles.

---

## ***Operating concept***

---

### ***Settings, first steps***

The following settings are possible:

#### **Units for distance measurement (DIST):**

- m = meters
- US ft = feet (in decimals)

#### **Units for angle measurement (ANGLE):**

- gon = 400gon
- 360d = 359°.999 (in decimals)
- 360s = 359° 59' 59" (sexagesimal)

#### **Display number of decimal places (ROUND):**

- high = 81°45' 24" (1" Interval)
- med = 81°45' 25" (5" Interval)
- low = 81°45' 20" (10" Interval)

For more informations refer to *section "Selecting units (UNITS)"*.

---

### ***Units in this manual***

Specifications within this manual always applies to the following units:

#### **Units of length:**

- in m (meter)
- in addition, within brackets in ft (feet)

#### **Units of angle:**

- in ° ' "
- in addition, within brackets in gon

#### **Units of temperature:**

- in °C
- in addition, within brackets in °F

## Display and keyboard

The TC600/TC800 unit has a dual-level interface. Keys are color-coded for each level.

**white keys:** active during measurements.

**orange keys:** key **MENU** activates orange keys for input of measuring and instrument parameters.

Display and keyboard

Cursor for indicating sub-program

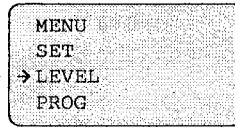

Display, max. 4x16 char.



Keys

## Key functions

Starting simultaneous measurement of distances and angles including data recording.

Deleting error messages, terminating functions and quitting of input fields without accepting values. Quitting sub-programs and functions.

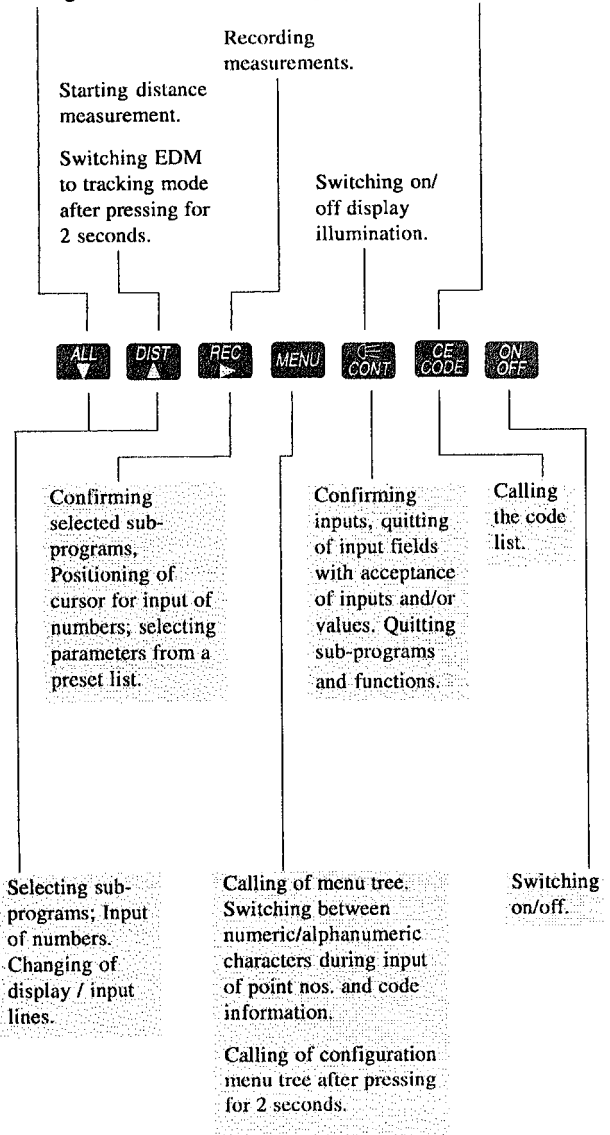

## Menu tree (Main menu)

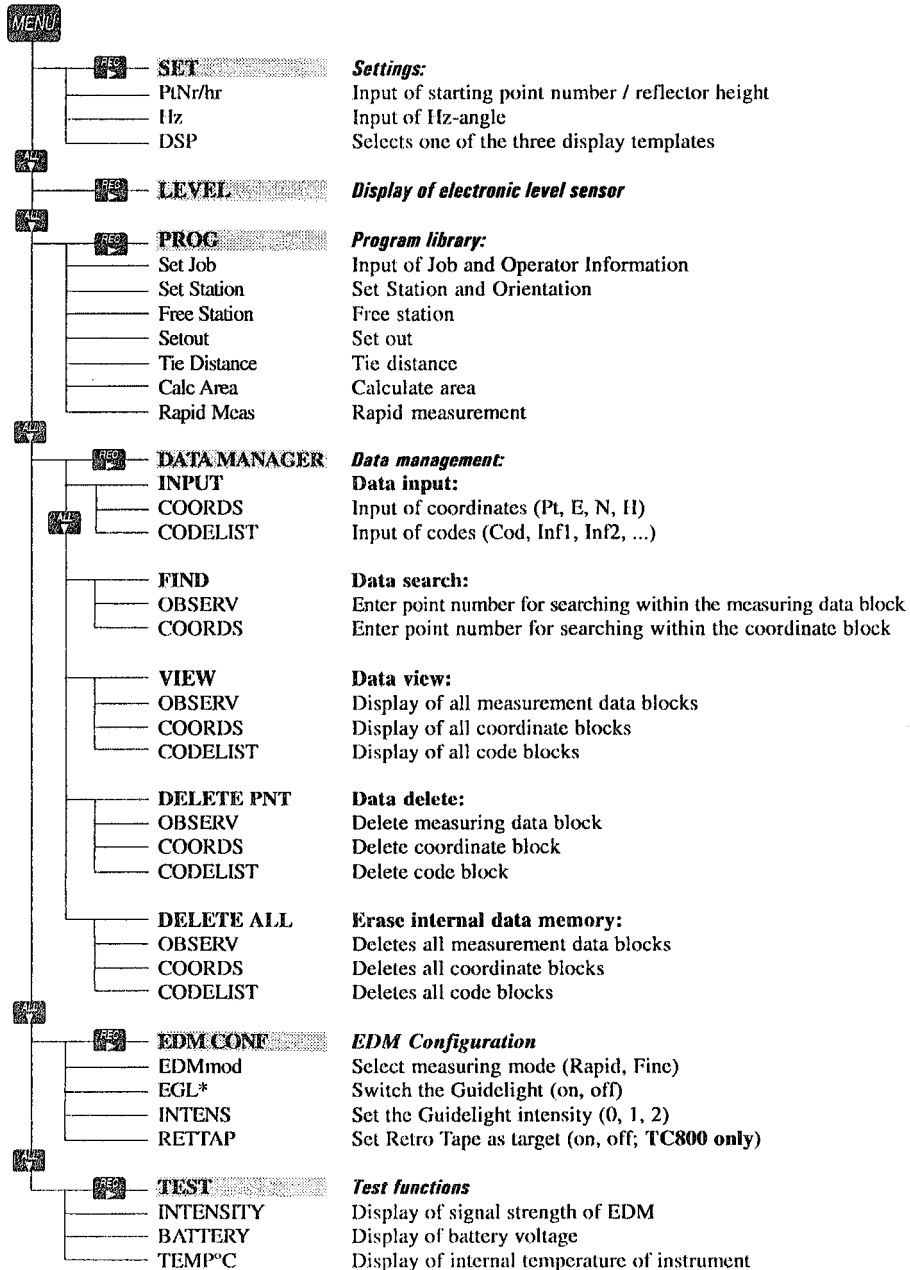

\* EGL is an optional accessory for TC800

## Menu tree (Configuration)

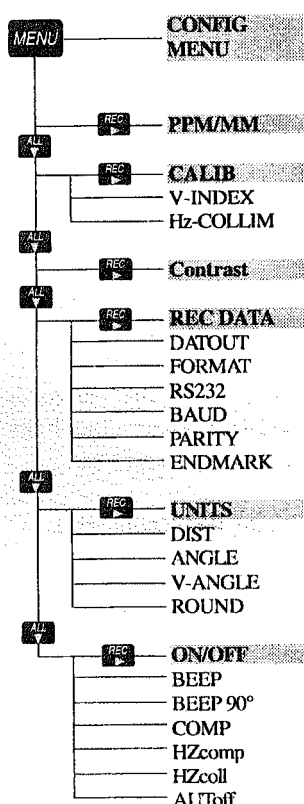

Press (for about 2 seconds) until the configuration menu appears.

### *Distance corrections*

#### **Instrument error:**

Determination of vertical-index error  
Determination of horizontal collimation error

### *Sets contrast and viewing angle of display*

#### **Settings for recording:**

Select data output (MEM, RS232)  
Length of data string (8, 16)  
Select recording template (MASK1, MASK2)  
Set transfer rate (300, 600, 1200, 2400, 4800, 9600)  
Set parity (EVEN, NONE, ODD)  
Set line end mark (CR/LF, CR)

#### **Units:**

Sets distance units (m, ft)  
Sets angle units (gon, 360d decimal, 360s sexagesimal)  
Select ref. plane of V-angle (V, +/-V, V%)  
Selects angle resolution displayed (low, medium or high)

#### **On / Off:**

Acoustic input signal (ON, OFF)  
Beep at 0°, 90°, 180° and 270° (ON, OFF)  
Compensator (ON, OFF)  
Correction Hz-angle (ON, OFF; only active if COMP = ON)  
Line of sight error (ON, OFF)  
Automatic switch-off (ON, OFF)

- Settings (SET)** Under **SETTINGS** specifications for measurements are entered (eg, point numbers, selection of display templates).
- Electronic level (LEVEL)** For the exact levelling-up of the instrument.
- Program library (PROG)** To make survey work easier, additional user programs are stored in the program library.
- Data management (DATA MANAGER)** Under **DATA MANAGER** measurements, coordinates or codes can be entered, deleted and displayed.
- EDM configuration (EDM conf)** Several settings for measuring can be carried out under **EDM CONF** (eg. selecting the EDM mode, Guidelight LIGHTS ON/OFF, setting retro tape as target, etc.)
- Testing (TEST)** **TEST** contains different functions specifying status of instrument (eg, battery etc.)







## Measure and record

ON  
OFF

After switching on and setting up the total station correctly, it is immediately ready for measuring.

### Display symbols

PtNr :	+00000000
Hz :	341°17'10
V :	87°55'10
 :	3.782

PtNr : Point number  
Hz : Horizontal angle  
V : Vertical angle  
 : Slope distance  
 : Horizontal distance  
 : Height difference  
E : Easting (value right)  
N : Northing (upper value)  
H : Height  
Code : Code (description)  
hr : Reflector height  
hi : Instrument height  
ppm : Atmospheric distance correction  
mm : Prism constant (Leica multiple prism = 0)

**Pointing and distance measurement**

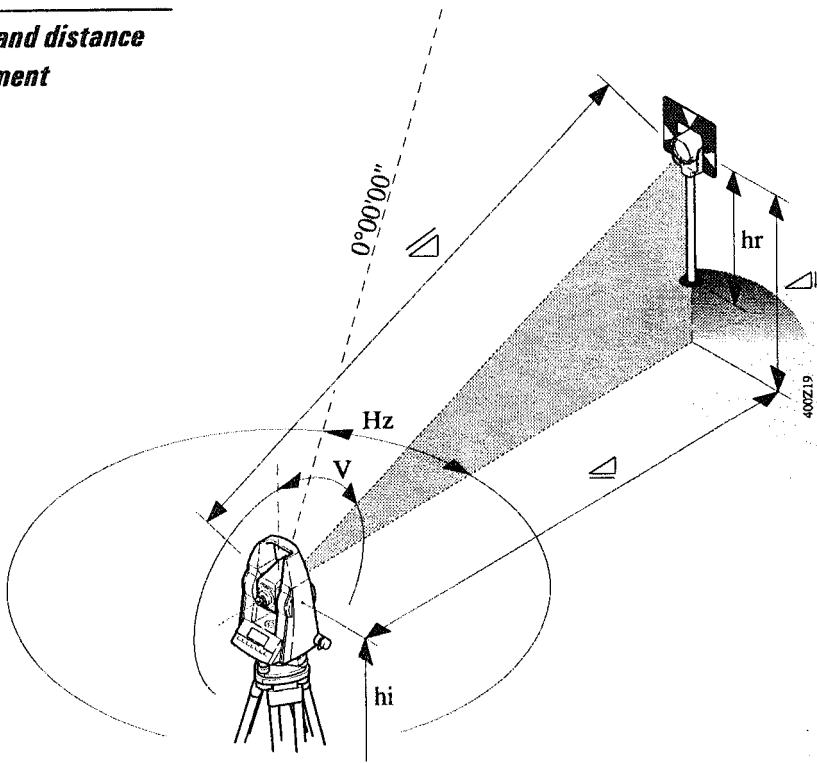

GPH1 prism holder with GZT4 target plate

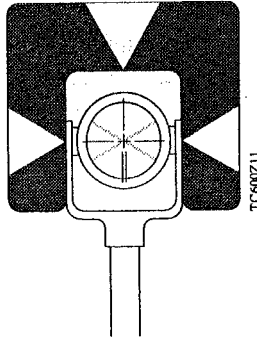

When pointing through windows or if reflecting surfaces are present, incorrect readings may result. For long-range work or for surveys under unfavorable conditions, multiple prisms (e.g. GPH3 three-prism holder) are necessary.



PtNr :	+00000000
Hz :	341°17'10
V :	87°55'10
∠ :	---

Simultaneous determination of distances and angles, including data recording.

The point number is incremented by 1 after each recording.

or



PtNr :	+00000000
Hz :	341°17'10
V :	87°55'10
∠ :	3.782

Distance measurement without automatic data recording. will record the measured distance.

The Hz-angle always refers to the actual pointing direction of the telescope.

### Example: for offset or hidden points



The distances and horizontal angles can be measured separately. First determine the distance and then adjust the direction (e.g. for surveying corners of buildings).

will record the data (refer to section "Recording").



The recorded V-angle always refers to the time of the completed distance measurement.

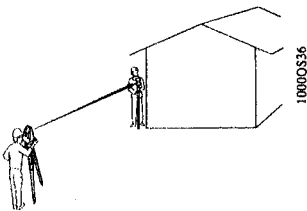

Measuring DISTANCE ( )

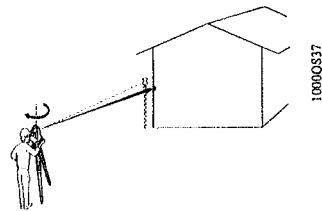

Storing DATA ( )

## Tracking mode



Press for 2 seconds and the tracking is switched on.



Stops tracking mode and returns into single mode.

## Display of recorded data



```
◇ MENU
  LEVEL      →
  PROG       →
  →DATA MANAGER
```



```
◇ *DATA MANAGER
  INPUT      →
  FIND       →
  →VIEW      →
```



```
√ *VIEW
  →OBSERV   →
  COORDS    →
  CODES     →
```

```
Obs : 0004/0047
Pt : +00000072
Type : Meas.
```

Measuring block

Total measured blocks (max. 1300, refer to section "Recording")



Press to scroll measured data upwards or downwards block by block. By keeping pressed down, measured data is scrolled continuously up or down.



Display of data, line by line within a measurement (block)

## Measure and record with coding

Codes can be assigned to each measurement to provide additional information to the measured point.

**Example of a code display in the measurement mode:**

**CE**  
**CODE**

```
List: 0000/0050
Code:      ?
In1 : CodeInp?
In2 :      ?
In3 :      ?
In4 :      ?
In5 :      ?
```

Codes can be entered directly or selected out of 100 pre-defined codes in the code list. Codes consists of max. 8 characters.

Alphanumeric code lists can be defined on the PC using TCTools and then transferred to the TC600/TC800 unit via RS232 interface (*refer to section "TCTOOLS"*). Codes also can be appended to the code list at the instrument using the menu options:

- DATA MANAGER
- INPUT
- CODES

# Coding

## Input a new code line to the code list

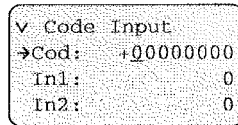
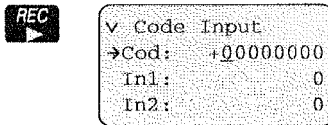
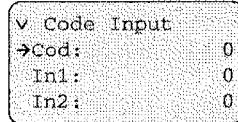
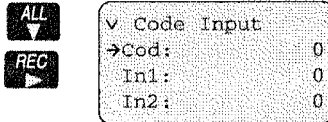
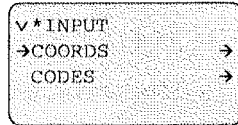
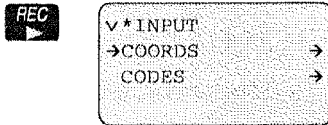
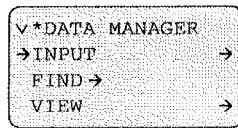
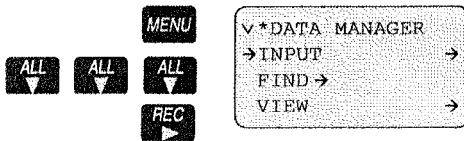

Up to 100 code blocks can be specified within a code list. Each code block consists of max. 6 elements, the code itself and five additional elements for description (In1, In2, ..., In5).

Appending additional codes at the instrument is carried out in the "DATA MANAGER". For the code itself letters and numbers are allowed.

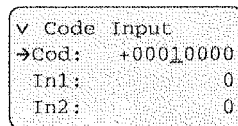
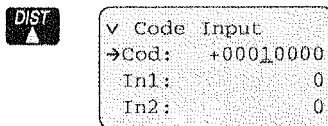

Press **REC** unless you reach the digit to be modified.



Change characters using the  / -key.

You can toggle between numeric and alphanumeric input mode with the -key.

Confirm your input with .

Similar to the "Cod" line is the additional information input in the lines "In1" .... "In5".

If you confirm a line containing only zeros the program ask you to store this code as follows:

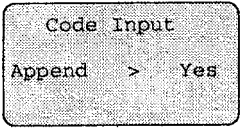

Toggles between YES/NO.

## Simple code input during measurements

During measurement (like you do it right after switching on the TC600/TC800) you have the possibility to code your measurement directly with one Codeline and max. five additional information entries.



```
List: 0000/0050
Code: ?
In1 : CodeInp?
In2 : ?
In3 : ?
In4 : ?
In5 : ?
```

At position 0000 of the code list, a code which allows individual modifications is predefined. This code will not appear in your DATA MANAGER unless you enter individual values using the keys.



```
√ CODE EDIT
→Cod: ?
In1 : CodeInp?
In2 : ?
```



To enter new codes into the code list *refer to section "Input a new code line to the code list"*.



The selected or edited code is assigned to the last measurement and stored in the observation area. The instrument returns to the measuring display.



Returns to the measuring display without recording the code.



## ***Using predefined codes from the codelist***

If you use a predefined codelist, you can easily select any code out of this list by stepping through the codelist. To create your own codelist refer to section "Input a new code line to the code list" or refer to "TCTools".

**CE**  
**CODE**

List: 0014/0050  
Code: House  
In1 : floor  
In2 : 215



**ALL**  
▼

**DIST**  
▲

Select the requested code using the arrow keys. For fast stepping, you may press the corresponding arrow key instantly.



To accept the selected code press **CONF** or **REC**.

## ***Additional entries to selected code***

There are 2 possibilities to define a special code which can be individually modified. Single digits or lines can be edited. Only lines with a "?" can be modified. Refer to section "Input a new code line to the code list" for similar ways of coding. To create a "?", use the arrow key  . The "?" is between 0 and 9. Question marks are allowed in the code line and in the description lines.

Follow the path:  
MENU - DATA MANAGER - INPUT - CODES

```
√ Code Input
Cod:      HOUSE
→In1:    +000000?
In2:     0
```

In order to go to the measuring display after code input press once  and then .

To append codes to the measurement, press  and search for your special code using the arrow keys.

To edit this code press . This will lead you directly to the line to be edited.

If no input is made, the value "0" will be recorded. Pressing  will clear the line containing a "?" and you can enter individual numeric or alphanumeric characters.



```
√ CODE EDIT
Cod:      HOUSE
→In1:    +00000000
In2:     0
```



Confirm your input and return to the measuring display.

In order to only edit single digits, use "!" instead of a "?" in the code input mode.

When editing just single digits, select the requested code using the arrow key.

For fast stepping, you may press the corresponding arrow key instantly.

To accept the selected code press .



```
√ CODE EDIT
Cod:          HOUSE
→In1:        +00000NO↓
In2:         0
```

Enter your individual code or description and confirm with .



When entering the "CODE EDIT" display, the cursor is always at the position of the first "!".

---

## User Programs



In order to use the software correctly and reliably, you must follow the instructions given in the user manual. You must also adhere to the directions given in the user manual for the product with which you are using the software.

---

### Introduction

The integrated programs enhance the functionality of the TC600/TC800 total station.

Daily survey work is simplified by using internally stored coordinates. This largely eliminates the risk of entering wrong informations in the field. Points with given coordinates or measured points can be used within the programs.

The following programs are installed in the instruments:

- Set Job and User (**Set Job**)
- Set Station and Orientation (**Set Station**)
- Free station (**Free Station**)
- Setting-out (**Setout**)
- Tie distance (**Tie distance**)
- Area computation (**Calc Area**)
- Rapid measurement and recording (**Rapid Meas**)



Programs are generally exit using the key .

## Set Job



```
◇MENU  
SET →  
LEVEL →  
→PROG →
```



```
√MENU*PROG  
→Set Job →  
Set Station →  
Free Station →
```



```
√Set Job  
→Job: JOB1  
Ope: MUE
```



Edit or input job name using and and confirm with .



Inputs are stored by the instrument; program back to the menu item **PROG**.



Cancel input line or quit without recording data.

Jobname and Operatorname can be entered. This is automatically stored in the Obs data range of the internal memory. The information can be read out and used as an information about the next stored measurements.



Data are not linked in any way to the Job.

## Set station coordinates (Station Coord)

The program "Station Coord" is used for setting station coordinates in the instrument. These can be entered manually or can be read from the internal memory.

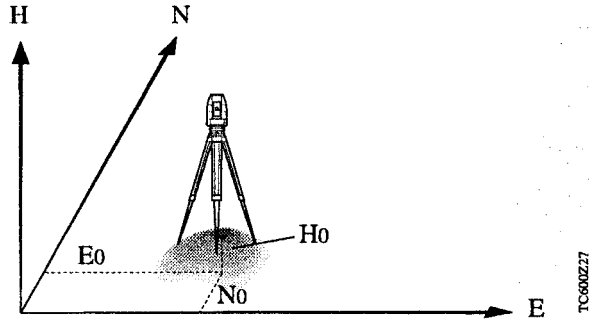

With manual input, the entered coordinates are stored in the OBS data range. The station coordinates are set simultaneously.

The coordinates are stored in the format PtNr, E, N, H.

MENU

ALL

```

◇ MENU
  SET          →
  LEVEL        →
  → PROG       →
  
```

REC

ALL

```

▽ MENU*PROG
  Set Job      →
  → Set Station →
  Free Station →
  
```

REC

DIST

```

◇ SET STATION
  → Get DATA> Keyb.
  Pt   : 00001100
  hi   : 1.600
  
```

REC

Optionally select manual input (**Keyb.**) or point search from internal memory (**IntMem**).

- point number entry
- instrument height entry

**Manual point entry  
(Keyb)**

(for alphanumeric entry refer to section "Entering point number")



```
0 SET STATION
->Get DATA> Keyb.
Pt : 00001100
hi : 1.600
```



Confirm manual point entry.



```
v SET STATION COORD
->E : 40.000
N : 45.500
H : 33.520
```

- Input of Easting (E0)
- Input of Northing (N0)
- Input of Height (H0)



Instrument stores the data in the Obs data range of the internal memory.



```
v SET STATION
•Pt : 00001100
E0 : 40.000
N0 : 45.500
H0 : 33.520
hi : 1.600
```



Sets the displayed coordinates as the instrument station coordinates and quits the program.

```
^ ORIENTATION
Get DATA>
->Pt : 00000001
```

The program automatically moves to the "ORIENTATION", for more information please refer to chapter "Orientation".

**Read the station  
coordinates from internal  
memory (IntMem)**



```
√SET STATION
→Get DATA> IntMem
Pt   : 00001100
hi   : 1.600
```

On the basis of the point number entered, the coordinates are searched for in the COORD area of the internal COORD area (RAM).



Enter instrument height.

The search for the point number entered always proceeds from the end to the beginning within the COORD area.

If the same point number is stored more than once, the last point in memory will be found.



```
SET STATION
•PtNr : 00000100
E0    : 40.000
N0    : 45.500

H0    : 33.520
hi    : 1.600
```

Displays coordinates.



```
^ORIENTATION
Get DATA> IntMem
→Pt   : 00000001
```

Confirms that station coordinates have been set. The program automatically moves to the "ORIENTATION", for more information please refer to chapter "Orientation".



**Orientation (of horizontal circle)**

It is possible to carry out the horizontal circle orientation with internally stored coordinates, manually entered coordinates and manual angle entries. The ORIENTATION is integrated in SET STATION.

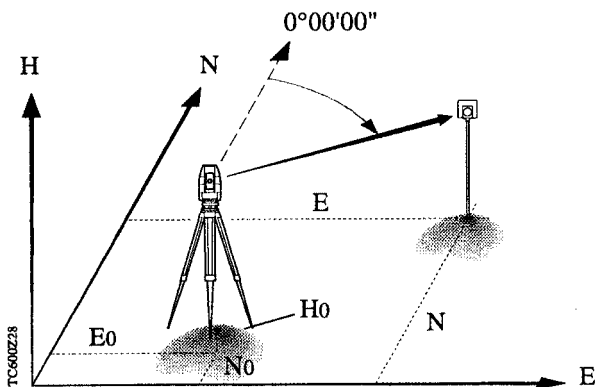

```

^ORIENTATION
Get DATA>IntMem
→Pt : 00000001
    
```

**DIST** **REC**

Optionally select manual input (**Keyb.**) or point search from internal memory (**IntMem**) or enter the angle directly (**Angle**)

**ALL**

Select line to enter the point number entry.

Enter point number directly or step through a list using the wildcard search. For wildcard search please refer to chapter "Wildcard search for point numbers", page 66.

**CONT**

Starts the search.

**DIST** **ALL**

```

Coord : 0001/0040
Pt : 5
    
```

Scroll through data and confirm requested point with

**CONT**

ORIENTATION  
Pt : P1  
Hz: 65°50'00  
V : 90°20'12

Selected orientation point is displayed but cannot be changed in this display.



ORIENTATION  
Orientation  
SET

Short display for confirmation: Orientation is set.

Data are stored by the instrument and the program returns to the menu PROG.



The option "**Angle**" acts in the same way as setting the horizontal circle reading in "**SET HZ**".

## Free Station

Calculates coordinates, height and horizontal circle orientation of the instrument position using min. 2 to max. 5 known points with coordinates.

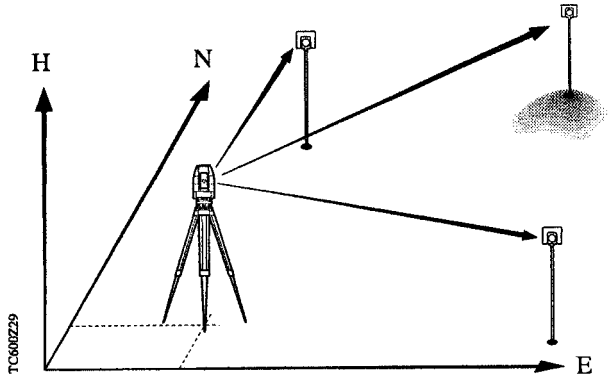

```
◇ MENU*PROG
  1.Set Job    →
  2.Set Station →
  →3.Free Station →
```



```
√ FREE STATION
→Pt :      0
hi :      0.000
```

Two different methods can be used, which the program automatically recognizes.

### Procedure 1

Distances are measured to all points. Station coordinates (E, N, H) are computed using a Helmert-Transformation. The computed standard deviation for the position (mp) is derived from the best fit.

### Procedure 2

Not all distances are measured. In this case the shortest measured distance is used to determine the station coordinates.

The point with the shortest distance is **not** used for orientation.

The shortest measured distance must be less than the calculated distance between the 2 target points, otherwise the error message "Bad Configuration" appears and the program terminates.

The computed standard deviation for the position (mp) refers to the accuracy of orientation (mo) used for the shortest measured distance.

**Valid for both procedures:**

The orientation is calculated by the arithmetic mean of all point orientations.

The calculation of the station height uses only those points with a measured distance and heights not equal zero.

The station height is the mean of the single heights.

The standard deviations for the orientation (mo) and the station height (mp) are computed using residuals derived from the arithmetic mean.

```
√ FREE STATION
→Pt :      44
hi :      1.200
```

Input of station number and instrument height (*for alphanumeric point entry see chapter "Settings" / "Entering point number and reflector height"*).



Confirm input.

```
FREE STATION
2 Faces > YES
```



Selection: Yes: 2 Faces  
No: 1 Face



Confirming the selection.

## Definition of target points

Point entries can be carried out in two ways:

1. IntMem: Points are searched in the data memory.  
Wildcards can be used (*refer to section "Wildcard search for point numbers", p. 66*).
2. Keyb.: Manual entry of coordinates



```
FREE STATION 1
Get DATA> IntMem
→Pt : +00000010
hr : 1.500
```

Input of point number and reflector height.





Confirm input.

```
FREE STATION ① — first point
Hz : 165°50'00
V : 90°20'51
△ : ----
```

Showing the measuring display; aim first point.



Measure and record the data simultaneously.



It is also possible to measure using  and .

```
FREE STATION 1
Other face
```

The program advises you automatically to change to the other face if selected before.



Measure and record the data simultaneously.

It is also possible to measure using  and .

```
② FREE STATION ② — second point
Get DATA> IntMem
→Pt : 45
hr : 1.200
```

Continue likewise with the second point.  
Enter point number and reflector height and confirm  
with .

Measuring and recording additional points is carried out  
in the same way.

After 2 measurements the results can be computed or  
the measurements can be continued with additional  
points (max. 5 points).

When using more than 2 points, the option to compute  
the position is made for each additional point used.

```
FREE STATION
Calculate> No
```



Selection: Yes/No  
No: Continue with more measurements  
Yes: Compute results



Confirming selection.

### Result indication



```
√ FREE STATION
• PT : 5
EO : 12.142
NO : 7.344
```

```
HO : 102.501
Ori: +87°23'11
hi : 1.250
mp : 0.012
mh : 0.034
mo : +0°01'05
```

Ori : Orientation correction  
hi : Instrument height  
mp : Standard deviation of position  
mh : Standard deviation station point height  
mo : Standard deviation orientation



Scrolling line by line.

## Indication of residuals:



```
RESIDUALS  1/3
Pt : 00000023
ΔHZ : -0°00'27
ΔDis: 0.021
ΔH : 0.015
```

No. of points measured

For each measured point the relevant residuals can be displayed.



Scrolling the measured points.



Page the elements of the residuals (e.g. to display ΔH).

If a distance was not measured the residual for ΔDist is zero.



```
FREE STATION
Record > Yes
```



Stores the station coordinates and orientates the horizontal circle. Returns to the PROG menu.

If the program is exit with  during "RESIDUALS" display the following message appears:

```
FREE STATION
Station not set
Exit > No
```



Selection: Yes/No



Confirming the selection.

## Setting out (Setout)

The setting-out technique can be based on the coordinate system of the points to be set out. The program calculates setting-out elements from manually entered or stored coordinates and station data. The option to enter angle and horizontal distance also exists.

Before you start setting out, make sure that the correct station point is set and the instrument has been oriented, when using coordinates.

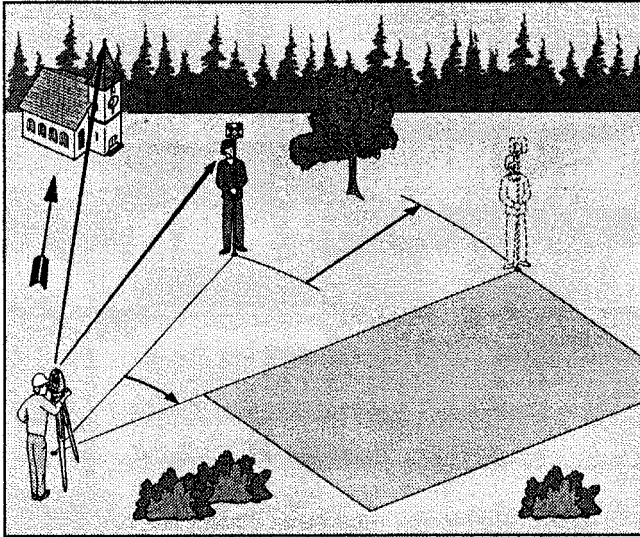

The "Setout" program supports the polar setting out technique. The divergence between the computed direction and the measured direction is displayed first.

MENU

ALL  
▼

REC  
▼

```
√MENU*PROG
Set Station →
Free Station →
→Setout →
```

REC  
▼

```
Pt : 15
◇ SETOUT
EO : 150.000
NO : 250.000
•HO : 500.000
hi : 1.200
```

The present station coordinates are displayed for inspection, but cannot be changed here.





Changes line by line. The corresponding point number can be viewed by scrolling to the top of the display.



```

SETOUT
Get DATA> IntMem
Pt  : +00001234
hr  :      1.550

```

```

OFF :      0.000

```

Input of point number, reflector height and height offset **Off**. The amount of **Off** is added to or subtracted from the height to be set out, in accordance with its sign. This takes account of infill, etc...

The entered point number is local within the application "Setout" and does **not** overwrite the system point number.

The options exist to search for coordinates in the COORD and MEAS data range (**IntMem**), for manual entries after switching to **Keyb** or for manual entries of angle and horizontal distance (**Angle**). It is possible to use "Wildcards" (refer to section "Data management" / "Searching for point numbers and multiple recordings").



```

Pt  : 00001234
ΔHz : 0°21'31
Δ $\triangle$  : 0.482
Δ $\triangle$  : 0.131

```

Turn instrument until  $\Delta Hz = 0^{\circ}00'00''$  (0.0000gon).

Repeat the measurements of the distance with  until the displayed difference in distance is within the required accuracy, i.e., close enough to "zero".



```

HZ  : 75°57'35
V   : 92°08'59
 $\triangle$  : 82.325
H   : 410.800

```

You can use the  key to switch between the upper and lower displays.



Continue with the next point.



Records the measurements and continues the program to enter the next point.

## ***Tie Distance (Missing line)***

With the program "Tie distance" the slope distance, horizontal distance, height difference and azimuth between two points is computed.

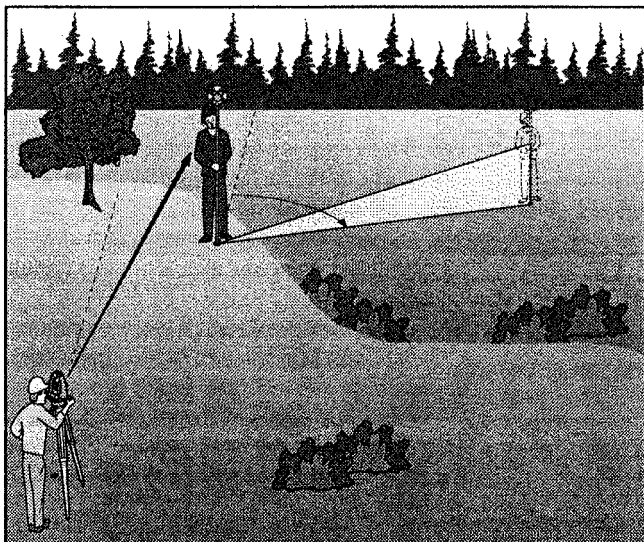

MENU

ALL  
▼

REC  
▶

```
◊ MENU*PROG
Free Station  →
Setout       →
→Tie Distance →
```

REC  
▶

```
◊ TIE DISTANCE 1
Get DATA> Keyb.
→Pt :      105
hr :      1.500
```

Start display:

- select desired method (**Keyb.**, IntMem, OnLine)
- Input of point number
- Input of reflector height (*for alphanumeric point entry see chapter "Settings" / "Entering point number and reflector height"*).

The points can be determined using three different methods:

**OnLine:** measurements to target points

**IntMem:** from coordinates read in the internal memory

**Keyb:** from coordinates entered manually

It is possible to combine all three methods.

The program supports the polygonal technique, i.e. the calculation of the tie distance between the two last points which were measured, entered or selected.



Confirming selection.

```
√ TIE DISTANCE 1
E :      15.200
N :      85.000
H :      512.500
```

Input of Easting

Input of Northing

Input of Height



```
◇ TIE DISTANCE 2
Get DATA> IntMem
→Pt :      106
hr :      1.400
```

Input of point data for tie distance 2:

- Select desired method (**Keyb.**, IntMem, OnLine)
- Input of point number
- Input of reflector height (*for alphanumeric point entry see chapter "Settings" / "Entering point number and reflector height"*).

```
◇ TIE DISTANCE
Az :      -0°05'30
Δ/△ :      15.241
•Δ/△ :      11.025
```

ALL  
▼

DIST  
▲

```
◇ TIE DISTANCE
Pt : 105
Pt : 106
Az : -0°05'30
```

ALL  
▼

DIST  
▲

```
◇ TIE DISTANCE
Δ/∠ : 15.241
Δ/∠ : 11.025
Δ/∠ : 1.725
```

Az : Display of azimuth  
Δ/∠ : Display of slope tie distance  
Δ/∠ : Display of horiz. tie distance  
Δ/∠ : Display of height difference

CE  
CONT

```
◇ TIE DISTANCE 2
Get DATA> Keyb.
→Pt : 00000006
hr : 0.000
```

CE  
CONT

Continue to next point/tie distance. Point two is now set as point one and the following measurement or the following data entry is used for the second point and so on.

CE  
CODE

Starts a new measurement sequence.

CE  
CODE

CE  
CODE

Press twice to cancel the program. Direct canceling is only possible when the input display is active.

```
TIE DISTANCE 2
Program End
```

After about two seconds the display returns to the PROG menu.

## Area computation (Calc Area)

This program computes an area from points which are connected by straight lines (eg, points 1...8). The number of points is unlimited. Points can be defined from continuous measurements (**OnLine**), from manual coordinate entries (**Keyb.**) or from existing point coordinates in memory (**IntMem**). Each time a new point is defined the user can select one of these three options.

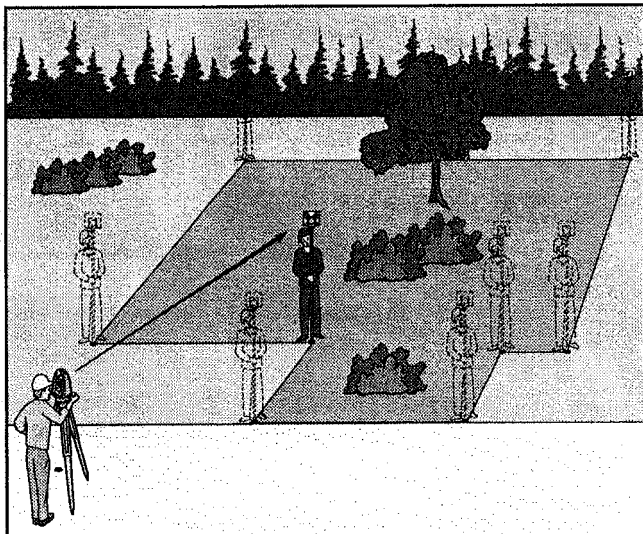

MENU

ALL  
▼

REC  
▼

```

◊ MENU*PROG
  Setout      →
  Tie Distance →
  →Calc Area  →
  
```

REC  
▼

```

√ CALC AREA  1
Get DATA> OnLine
→Pt :      0000001
hr :      1.400
  
```

Choose between "OnLine", "Keyb." or "IntMem" and enter the pointnumber using the **DIST** **ALL** -keys.



```

CALC AREA 1
Hz : 78°46'55
V : 102°53'55
/ : ----

```

Starts to retrieve the coordinates for the entered point from internal memory.

Or:

Manual input of coordinates.



```

v CALC AREA 1
Get DATA> Keyb.
→Pt : 00000001
hr : 1.400

```



```

v CALC AREA 1
→E : 15.200
N : 85.000
H : 512.500

```

After recording manually entered points, the instrument is automatically ready to measure the next point.



```

◇ CALC AREA 2
Get DATA> Keyb.
→Pt : 00000005
hr : 1.000

```

After recording you have the opportunity to change the selection when entering coordinates manually.

To view calculated area:

**CE**  
**CODE**

```
√ CALC AREA
m^2 :
Area : 473.211
PtCnt : 6
```

The polygonal area is closed to the start point.  
Display of area in m<sup>2</sup> (ft<sup>2</sup>) or hectares (acres) and  
number of used points.

For entering data using "Online" mode:

**CE**  
**CODE**

for code entry

**CE**  
**CODE**

for Pt/hr entry press 2 seconds; press **CE** again to  
display computed area.



For computing an area minimum three points must be  
used.

**CE**  
**CONT**

Continue with further points, or

**CE**  
**CODE**

```
CALC AREA
Program End
```

Short display for confirming the termination. Back to  
menu PROG.

### Conversion factors used

1 ft<sup>2</sup> = 0.092903 m<sup>2</sup>

1 acre = 0.404686 ha

## Rapid measurement and recording (Rapid Meas)

This program enables quick measurements and data recording. It is designed for fast and easy data logging using a minimum of keyboard interaction. This program is ideal for high density tacheometry with limited coding requirements (e.g. tacheometry for volume determination, contours in open field, etc. ... ).



```
^MENU*PROG
Tie Distance  →
Calc Area     →
→Rapid Meas  →
```



```
◇RAPID MEAS
EO : 100.000
NO : 200.000
•HO : 300.000

hj : 1.300
```

The present station coordinates are displayed for inspection, but cannot be changed here.



Scrolls line by line. The corresponding point number can be viewed by scrolling to the top of the display.

### Measurement procedure

Switches to tracking mode; it is now permanently active. Distances are measured with 0.5-second interval (TC600) or 0.3-second interval (TC800). The measurements are recorded in the measurement-data range.

The reflector must be sighted so that the Hz- or V-drive is continuously in motion until the reflector has been targeted with the accuracy required. The data are recorded as soon as the change between the Hz- or V-angle amounts to less than 16" ( 50<sup>cc</sup> ) between two valid distance measurements.

If, after this recording, the instrument remains in the rest position, no additional data are recorded even though the distance continuous being measured.

The recording mode is reactivated after there has been a change of at least 5' 24" (= 0.1 gon) to the last recorded horizontal direction.





```

v RAPID MEAS
→Pt :      1
hr :      1.200

```

Enter pointnumber and reflector height.



```

DIST*TRACKING
ppm :      0
mm :      0

```

Above display appears for a moment.

The program activates the Tracking Mode automatically.

```

Pt :      1
Hz :      13.672
V :      100.261
/ :      2.803

```

Display of measured values depending on selected display mask.



```

REC :
Pt :      1

```

Measurement is accepted and stored. Data recording is confirmed by a double Beep.  
Subsequently, the point number is automatically incremented by 1.

The -key can be used at any time during the program to select or enter coding.



```

List : 0000/0004
Code :      ?
In1 : CodeInp?
In2 :      ?

```



Press for about two seconds to enter a new point number or reflector height.



Press twice to exit the rapid measurement program.

RAPID MEAS  
Program End

The program is terminated.  
Back into menu PROG.



This program requires the prisms to be sighted quickly and a good experience in observations techniques. The EDM is permanently switched on, and therefore power consumption is greater than usual.

# Settings (SET)

**Entering point number  
and reflector height  
(SET PtNr/hr)**

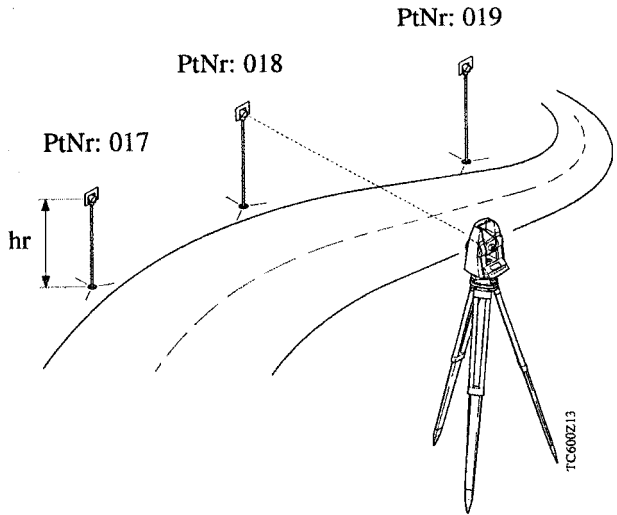

**MENU**

```
MENU*SET  
→PtNr/hr  
Hz  
DSP
```

**REC**

**REC**

```
MENU*SET*PtNr/hr  
  
Pt : +00000017  
hr : 0.000
```

This point number is recorded with the measurements and is always automatically incremented by "+1" after recording.

The point number can also be transferred to the instrument from an externally connected PC.

Command structure :  
(\_ = space char.)  
PUT/11....+12345678\_CRLF

---

**Alphanumeric entry of  
point number**

Use the **MENU** key to toggle between numeric or alphanumeric entry mode.

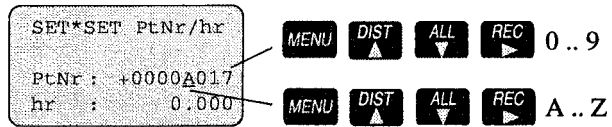

**Point number search**

*Refer to section "Searching for point numbers and multiple recordings (FIND)".*

---

**Entering reflector height**

The reflector height is entered under **hr:** and stored with each recorded measurement.

## Setting the horizontal circle (Hz)

*1st variant*

= sets Hz to  $0^{\circ}00'00''$  by entering the Hz-value directly from the keyboard.



```
MENU*SET
PtNr/hr
->Hz
DSP
```



```
MENU*SET*Hz
Hz : 0°00'00"
Hz input or
CONT to hold
```

Type in:  $0^{\circ}00'00''$



Hz - direction is held on  $0^{\circ}00'00''$  (0.0000 gon).



Changes the Hz value. Changing the sign will turn the Hz counting.

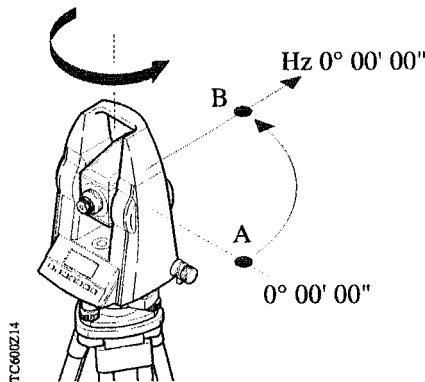

Aim at point B.



```
MENU*SET*Hz
Hz* : 0°00'00"
CONT to release
```

The Hz-angle to the new point (B) is now  $0^{\circ}00'00''$  (0.0000 gon).

Return to measuring display.

2nd variant

= sets Hz to a specified value by turning the instrument



```
MENU*SET
SET PtNr/hr
->Hz
DSP
```



```
MENU*SET*Hz
Hz : 0°00'00
Hz input or
CONT to hold
```

Turn instrument until required angle (e.g. 45°00'00" , 50.0000 gon) is indicated.



Hold value.

Aim at the corresponding point.

```
MENU*SET*Hz
Hz : 45°00'00
CONT to release
```



The target point Hz is now 45°00'00" (50.0000 gon).

## Setting the display mask (DSP)



```
VMENU*SET
SET PtNr/hr
Hz
→DSP
```

Depending on desired use, 3 different display masks can be selected on the TC600/TC800 unit.

### Display-masks



#### Display of mask 1 :

```
PtNr : +00000005
Hz   : 341°17'10
V    : 87°55'10
△    : 3.782
```

Point number  
Horizontal angle ( Hz )  
Vertical angle ( V )  
Slope distance



#### Display of mask 2 :

```
PtNr : +00000005
E    : -----
N    : -----
H    : -----
```

Point number  
Easting  
Northing  
Height



#### Display of mask 3 :

```
Hz   : 341°17'10
V    : 87°55'10
△    : -----
△    : -----
```

Horizontal angle ( Hz )  
Vertical angle ( V )  
Horizontal distance  
Height difference



Confirm selected display mask within 5 seconds.

# Data management (DATA MANAGER)

**DATA MANAGER** contains additional functions enabling the input and check of data in the field.

MENU

ALL

0 MENU  
LEVEL →  
PROG →  
→DATA MANAGER →

REC

√\*DATA MANAGER  
→INPUT →  
FIND →  
VIEW →

DELETE PNT →  
DELETE ALL →

**The following additional functions are available:**

- Input of codes and coordinates (**INPUT**)
- Searching for point numbers and multiple recordings of identical point numbers (**FIND**)
- Display of stored data (**VIEW**)
- Erasing measured data, coordinates and codes in the codelist (**DELETE PNT**)
- Erasing the complete range of the selected file (**DELETE ALL**)

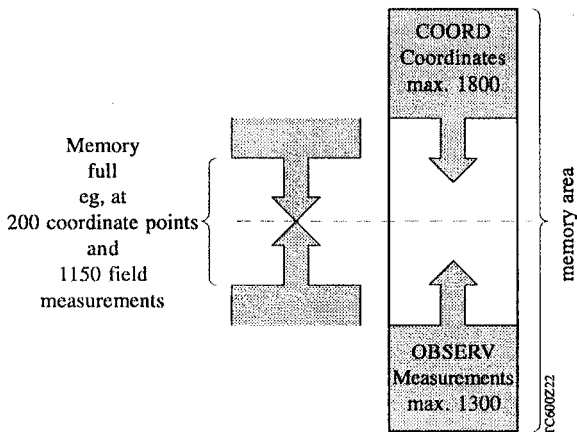



## ***Input of coordinates and codes (INPUT)***

```
√ *DATA MANAGER
→ INPUT      →
  FIND       →
  VIEW       →
```

Coordinates can be entered via the keyboard and appended to the existing coordinates (fixpoints) and codes can be appended to theodelist.

## ***Coordinate entry (COORDS)***



```
√ *INPUT
→ COORDS   →
  CODELIST →
```



```
√ Coord Input
→ Pt :      1
  E  :      0.000
  N  :      0.000

  H  :      0.000
```



Confirm data entries.



Confirm the display and store the coordinates.



Quit the function.

## Code input (CODES)



```
√* INPUT
COORDS      →
→CODELIST  →
```



```
√ Code Input
→Cod: +00000000
In1: 0
In2: 0
In3: 0
In4: 0
In5: 0
```

Input for a new code.

Up to 100 code blocks each with 6 elements can be specified. The newly entered code is appended to the existing list.



Confirm the inputs in each individual line.



```
Code Input
Append > Yes
```



Toggles between Yes/No.



Confirm **Yes** : The codes append to the code list.  
**No** : Returns to input mode without recording.



Quit the function.

## Searching for point numbers and multiple recordings (FIND)

This function enables display of data blocks, searches for point numbers and multiple recordings of the same point numbers, including the use of "Wildcards".



```

0 *DATA MANAGER
  INPUT      →
  →FIND→
  VIEW →
  
```



```

√ *FIND
  →OBSERV   →
  COORDS    →
  
```



```

PtNr Obs/Find

Pt   = +xxxxxxxx
  
```

Enter the point number to be searched for directly or use wildcard search to choose within the data area.



Starts the search for the point number. Always the last stored point within the data range is found.

```

Obs : 0003/0047
Pt   +xxx1xxx5
Type:      Meas.
  
```



View of single elements.



Step through the list of measurements, referring to the search criteria.



Quit submenu.

```

PtNr Obs/Find

Pt   = +xxx1xxx5
PtNr not found
  
```

Error message if point number was not found.

Delete error message with .

This searching procedure applies for both, the OBSERV and for the COORDS data range.

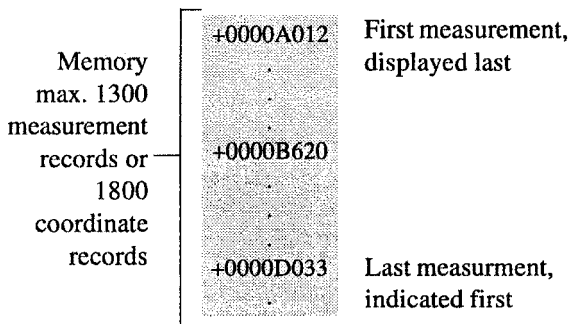

### Wildcard search for point numbers

Point numbers can be searched in application programs or in the data display using "Wildcards". They can be used to search for specific character groups or character sequences.

#### Example:

**+xAxx9xxx** This example searches for all point numbers counting from left to right with an "A" at the 2nd place and a "9" at the 5th place and presents the points in a list. The character "x" is selected when scrolling between "9" and "0".

The following character set exists for numeric entries:  
0 1 2 3 4 5 6 7 8 9 x 0 1 2 ... etc.

---

### *Searching for several data blocks with the same point number*

If a specific point number is shown, the cursor keys can be used to scroll further points fulfilling the wildcard search criteria. The direction of search is always from the last stored point towards the first point.

## Display of stored data (VIEW)

Measuring data ( **OBSERV** ), fixed-points ( **COORDS** ) and code lists ( **CODELIST** ) can be selected individually.



```

◇ *DATA MANAGER
  INPUT      →
  FIND       →
  →VIEW      →
    
```



```

v *VIEW
→OBSERV     →
  COORDS     →
  CODELIST   →
    
```



```

Obs :   0004/0047
Pt    :           45

Type:           Meas.
    
```



Scrolls data block by block upwards and downwards. Always starts with the last data block (eg, **0047**) within the selected data range ( **OBSERV**; **COORD**; **CODELIST** ).



Viewing the single elements.



Quit sub-program.

If the file **OBSERV** was deleted or if this data range contains no data the following display appears:

```

*VIEW *OBSERV
no data found
    
```

Delete warning with .

**Delete measurements,  
coordinates and codes  
(DELETE PNT)**

In all three options, the blocks stored in the total station  
are indicated:

- Measurements ( **OBSERV** ) from measuring range
- Coordinates ( **COORDS** ) from coordinate range
- Code blocks ( **CODELIST** ) from code list



```
◇ *DATA MANAGER
  FIND      →
  VIEW      →
  →DELETE PNT →
```



```
√ *DELETE PNT
→OBSERV    →
→COORDS    →
→CODELIST  →
```



```
Obs : 0004/0047
Pt   : 45
Type: Meas.
```



Scrolling to the point to be deleted.



Viewing the single elements.



```
PtNr Obs/Del.
Delete > No
```



Toggles between Yes/No.



Confirm selection. Yes will delete the selected block.



Quit the function.

**Delete the complete  
range of measurements,  
coordinates and codes  
(DELETE ALL)**

All points in the data range OBSERV (measured data), COORDS (coordinates) und CODELIST (code lists) can be deleted. Each data range can be deleted individually.



```
^*DATA MANAGER
VIEW          ->
DELETE PNT   ->
->DELETE ALL  ->
```



```
v*DELETE ALL
->OBSERV      ->
COORDS       ->
CODELIST     ->
```



```
Erase Data
Nr of Blks:  35
Erase  >    No
```



Toggles between YES/NO.



Confirm selection.



Quit the function.



Confirming selection "Yes" will delete all data stored in the corresponding data range.

# EDM Configuration (EDM CONF)

MENU

ALL  
▼

```
◊ MENU
  LEVEL →
  DATA MANAGER →
  → EDM CONF →
```

REC  
▶

```
√ MENU * EDM CONF
→ EDMmod> FINE
EGL > OFF
INTENS> 0

RETTAP> OFF
```



The EDM configuration is only possible with the TC800 instruments.

## EDM mode

Selecting measuring mode FINE or RAPID.

Mode	Accuracy	Meas.time
FINE	2 mm + 2 ppm	2.5 sec.
RAPID	3 mm + 2 ppm	0.9 sec.



## EGL (Guide Light)

All TC800 instruments can optionally be equipped with Guide Light EGL1. The person at the prism can be guided by two blinking lights directly to the line of sight. The lights can be sighted up to 150 m away from the instrument. Stake out will be much easier with EGL1.

MENU

ALL

```

◇ MENU
  LEVEL      →
  DATA MANAGER →
  → EDM CONF →
    
```

REC

```

√ MENU*EDM CONF
→ EDMmod>   FINE
  EGL >     OFF
  INTENS>    0
    
```

Turns the Guide Light (EGL) ON or OFF.

To achieve best performance, when using the Guide Light, the intensity should be adjusted for different light conditions (*see chapter "INTENS"*).

REC

Select value.

CONT

Confirm the selected value.



Possible with TC800 equipped with EGL1.

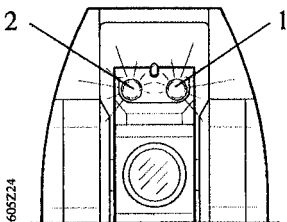

- 1 Exit for blinking red LED
- 2 Exit for blinking yellow LED

607259

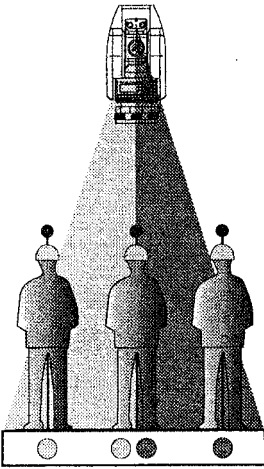

At a target distance of 100 meter (330 ft) a red/yellow blinking cone of light at both sides with a width of 6m (20 ft) each is formed. As a result, guiding to the line of sight of the instrument is much easier and faster.

Between both cones of light an about 30 mm wide sector is created. Within this sector both colours are blinking simultaneously. In this case the prism is already right in the line of sight.

Operating range: 5 - 150 m (15 - 500 ft)

Divergence: 12 m (40ft) at 100m (330 ft)

---

## ***INTENS***

Using the Guide Light EGL a corresponding value for the intensity can be set.

Settings "0", "1", or "2" are possible.

## RETTAP

Sets the EDM into a mode to measure to prisms or reflector tapes (= retro tape; only possible with the TC800 instrument).

One of two different reflector types can be selected:

ON: Set the retro tape target as reflector

OFF: Set the prism as reflector



Pay attention to the correct setting: retro tape and prism have different prism constants. Switching from prism to retro tape will set the internal prism constant for Leica retro tapes automatically to 0.34mm, but the displayed prism constant shows "mm=0.000". If the EDM is switched from retro tape to prism, the last entered value for the prism constant is valid again.



The retro tapes should always be attached in the preferential direction (Leica logo readable acc. to fig.).

Retro tapes can be attached permanently to an object for the purposes of monitoring or for frequent repeat measurements. A retro tape may also be useful for the once-and-for-all marking of a point which is difficult to access.

Normally, measurements are still possible up to a horizontal or vertical inclination of  $\pm 45^\circ$ . Inclined measurement will reduce the range performance. Best performance is achieved when sighting perpendicular to the surface of the retro tape.

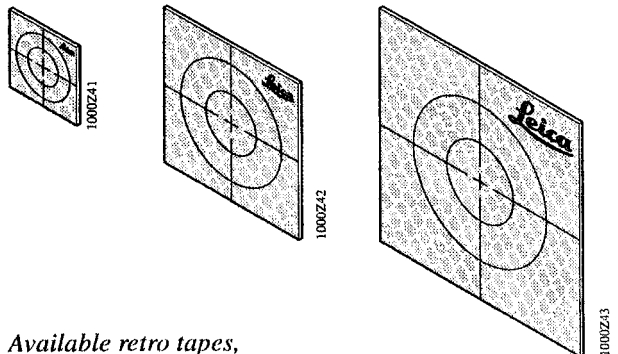

*Available retro tapes,  
attached in the preferential direction.*

### Special features

- No loss of accuracy when retro tape is perpendicular to the line of sight
- Measurement precision  $\pm 3\text{mm}$  when retro tape is at  $45^\circ$ .
- For short ranges of up to 10m (33ft) the additional lens 632 364 is required. (Measuring error without additional lens  $> 10\text{mm}$ ). It is important that the additional lens is placed to the instrument in the correct position (aperture vertically) !

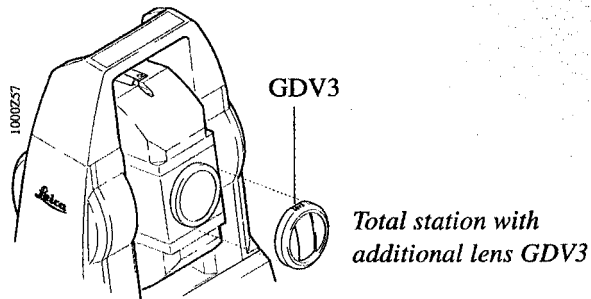

### Technical data for measurements to retro foils

Target-mark size [mm]	Range [metres]	Accuracy * (standard deviation)
20 x 20	2 to 40	3 mm
40 x 40	20 to 100	3 mm
60 x 60	60 to 180	3 mm

\* The accuracies quoted are valid when the retro tape is targeted at an angle of up to  $45^\circ$ .

## Testing the instrument

Test functions are for displaying instrument parameters and status.

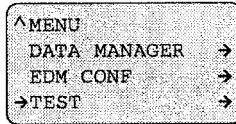

### Battery and instrument temperature

After the submenu has been called, the instrument temperature and the battery status is displayed. Low battery charge also triggers (even during a measurement) an acoustic signal and the warning "Battery low".

With low battery charge, distances cannot be measured and the instrument switches off automatically.

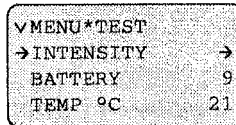

9 = Battery full  
1 = Battery low



```
√MENU*TEST
→INTENSITY    →
BATTERY       9
TEMP °C       21
```

```
*TEST*INTENSITY
>■■■■■■■■<
28%
```



Exit "INTENSITY" display.

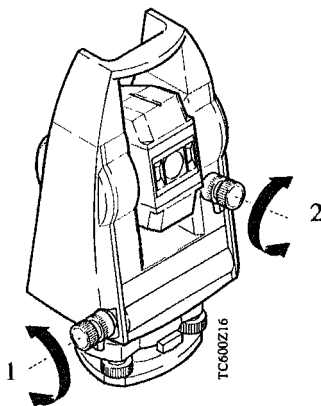

Under difficult measuring conditions (e.g. fog) the TC600/TC800 unit can be optimised to the prism using this function.

- Align TC600/TC800
- Adjust the fine drives (1, 2) until the max. value (e.g., 28%) is reached.
- Measure the distance.

# Configuration

Under "Configuration", specific settings can be carried out with the TC600/TC800 unit so the instrument is optimally set to particular survey work.

**MENU**

Press (for about 2 seconds) until the configuration menu appears.

√CONFIG MENU	
→PPM/MM	→
CALIB	→
CONTRAST>	2
REC DATA	→
UNITS	→
ON/OFF	→

---

## Distance corrections

---

### Meteorological correction (ppm)

The distance measurement is affected by the meteorological conditions. The distance can be corrected with appropriate **ppm** values. The ppm values for temperature and atmospheric pressure are obtainable from the diagram in section "Technical data". Instead of the atmospheric pressure the mean height above sea level of the survey site may be used for interpolation. For example, 10°C (18°F) temperature difference makes a difference of 1mm in a measured distance of 100 m = 10 ppm.

(2 secs) **MENU**

√CONFIG MENU	
→PPM/MM	→
CALIB	→
CONTRAST>	2

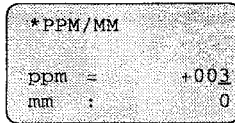

Activate input.



Enter value.



Confirm input and continue to enter the prism constant (mm).

### Prism constant (MM)

The prism constant **MM** for Leica circular prisms is 0. It must be determined when using other types of prism. The prism constant must be always entered in units of (mm).

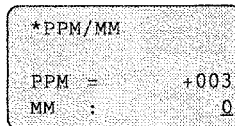

Confirm input. The value is stored and also available after switching off the total station.

During a distance measurement the instrument displays both of the correction values (**PPM**) and (**MM**) for your information.

Manually set prism constants are automatically set to "0" when "RETTAP > ON" (under "MENU - EDM CONF).

The instrument automatically uses the Leica reflector tape constant (c = 0.34 mm) internally in this mode. When resetting to "RETTAP > OFF" the previously used prism constant for prisms is reactivated.



## Determine instrument errors

(2 secs) **MENU**

```

v CONFIG MENU
  PPM/MM      →
  → CALIB     →
  CONTRAST>   2
  
```

**ALL**

**REC**

```

v *CALIB
  → V-INDEX   →
  Hz-COLLIM   →
  
```

### Vertical index error (V-Index "i")

The vertical circle should read exactly 90° (100 gon) when the line of sight is horizontal. Any deviation from this figure is termed vertical index error (i).

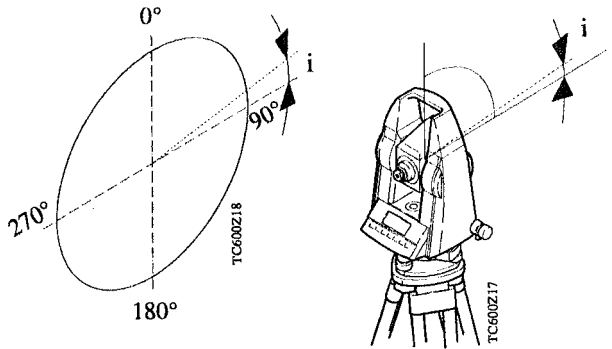

The stored vertical index error is displayed as an angular value in the units selected.

Before determining the vertical-index error use the electronic level to level up the instrument correctly.



1.

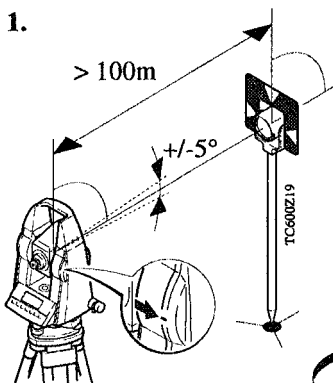

2.

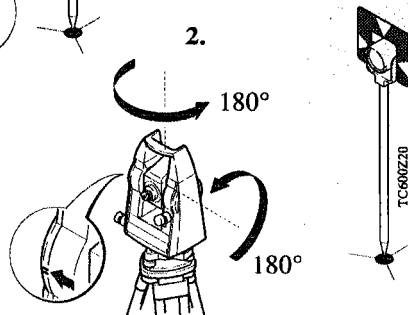

```
*CALIB*V-INDEX
I      0°00'00
Inew:  ---
>Measure Index<
```

```
> Aim Point <
> Wait <
> Other Face <
> Wait <
> Set Value? <
```

```
*CALIB*V-INDEX
I      0°00'00
Inew:  -0°23'52
> Set Value? <
```



Adopt the calculated value or



retain the old value and switch back to menu CALIB



When you determine the vertical index error the electronic level is adjusted at the same time.

**Line-of-sight error  
(Hz-Collimation "c")**

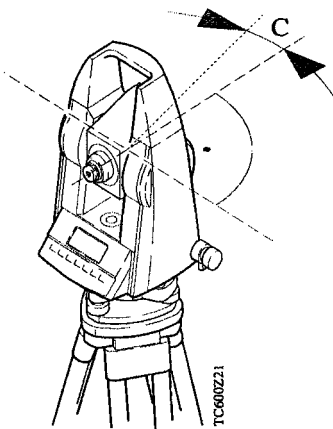

The line-of-sight error or collimation error (C) is the deviation from the right-angle between the tilting axis and the line of sight. It is determined and stored in a similar manner to the vertical-index error and corrects the Hz-angle. The value for the correction depends on the vertical angle.



```
v*CALIB
V-INDEX      →
→Hz-COLLIM   →
```



```
CALIB*Hz-Collim
C          0°00'00
Cnew:     0°16'12
>Measure Collim<
```



```
> Aim Point <
> Other Face <
> Set Value? <
```



Adopt the calculated value and return to the normal measuring mode.



Retain the old value and return to the menu CALIB. By doing so, you can quit the menu at any time without saving the made corrections.



Index- and line-of-sight errors can change with time and temperature. They should, therefore be newly determined before the first use, before precision surveys, after long periods of transport, before and after long periods of work, and if the temperature changes by more than 10°C (18°F).

---

## ***Contrast***

Adjusting the display contrast or reading angle.

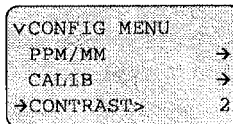

- 0 : Optimal contrast if the display is above the eye level of the user (reading from below)
- 1,2 : Ideal for reading at eye level
- 3: Ideal for reading at eye level below the display.

## **Data and recording parameter (REC DATA)**

The **REC DATA** commands contain all relevant parameters and settings for data recording. Set these parameters as required and check the communication before starting recording for the first time.



```
∅ CONFIG MENU
  CALIB           →
  CONTRAST>      2
  →REC DATA     →
```



```
√*REC DATA
  →DATOUT >      MEM
  FORMAT >        8
  RS232 >         MASK1

  BAUD >          9600
  PARITY >         EVEN
  ENDMARK>        CR/LF
```



Setting the desired parameters.

Possible settings:

DATOUT MEM, RS232

FORMAT 8, 16

RS232 MASK1, MASK2

BAUD 300 \ 600 \ 1200 \ 2400 \ 4800 \ 9600

PARITY EVEN \ ODD \ NONE

ENDMARK CR/LF \ CR



Confirm the input.

### **DATOUT**

To record measurements, a data recorder can be connected to the serial data port (RS232 interface).

The parameters of the serial interface are already set for standard Leica parameters (9600, EVEN, CR/LF). They remain stored after switching off the total station.

To use other data recorders (e.g. IBM-compatible PCs, Handheld computers, etc.) the interfacing parameters may need to be changed. The communication via the RS232 interface requires a certain protocol containing the exact command structure (for more information refer to the handbook "Leica Instruments online").

### Settings for data communication GPC1:

Call up "MAIN" in the menu of the GPC1. Set the transfer parameters (2400 baud, EVEN, CRLF) for the COM2 interface.



Do not turn the Total Station during measurements until data recording is finished. The current horizontal direction is always transmitted !

### Internal data recording

The measured data (**OBSERV**) and the fixed-point coordinates (**COORDS**) are stored in the internal memory (refer to section "Data Management"). The internal memory can store information for a maximum of 1300 measurements or 1800 coordinate points. It is possible to store, for instance, 1150 field measurements and simultaneously 200 coordinate points in the internal memory.

New data are always appended to existing data.

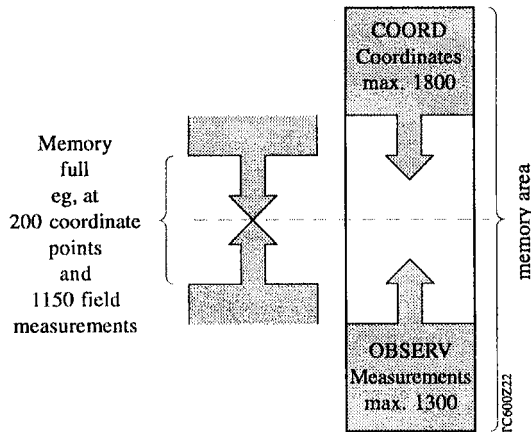

**FORMAT** The Leica GSI-format can be output as a 8 or 16 digit string. However, this format setting is only relevant for the serial output of data and has no effect on the entries into the instrument. This setting is only responsible for the output string size. As an example, if a 12-digit point number in the 8-character-mode is output only the last 8 digits are transferred. Internally, however, always 16-digit strings are used, in order to guarantee a later output in another data format.

Using an entry of a 12-digit point number or station designation as an example the format generated by the instrument is described below:  
(The 12-digit entry is always possible in both cases).

Pt.No. input: 123456789012

Setting 8 characters (**FORMAT 8**) :

Display indication: 56789012

Output string: 110009+56789012 (Leica GSI format)

Setting 16 characters (**FORMAT 16**) :

Display indication: 123456789012

Output string: \*110001+0000123456789012  
(Leica GSI-Format)

Int. stored. 123456789012

**RS232** Two data templates are available for external recording:

**MASK1** Pt Nr, Hz, V, slope distance, ppm/mm,  
hr, hi

**MASK2** Pt Nr, Hz, V, slope distance, E, N, H, hr

Coordinate points are always stored in the format PtNr,  
E, N, H.



The settings of MASK1 and MASK2 have no affect to the data stored internally.

## Selecting units (UNITS)



```
√CONFIG MENU
  CONTRAST>    2
  REC DATA    →
  →UNITS       →
```

### Units for distance measurement (DIST)



```
√*UNITS
→DIST >      m
  ANGLE >    360s
  V-ANGL >   V
```

- m = meter
- US ft = feet (decimal)



Confirm selection.

### Units for angle measurement (ANGLE)



```
◇*UNITS
  DIST >      m
→ANGLE >    360s
  V-ANGL >   V
```

- gon = 400gon
- 360d = 359°.999 (in decimals)
- 360s = 359° 59' 59" (sexagesimal)



Confirm selection.



## V-Angle



◊*UNITS			
DIST	>	m	
ANGLE	>	360s	
→V-ANGL	>	V	

Setting vertical-angle indication.

**V** = zenith angle (zenith = 0)

**±V** = vertical angle (horizontal = 0)

**V%** = slope: (horizontal = 0%), rise (+%); fall (-%)



Confirm selection.

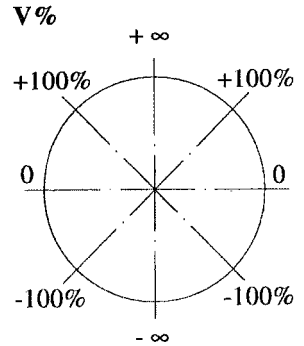
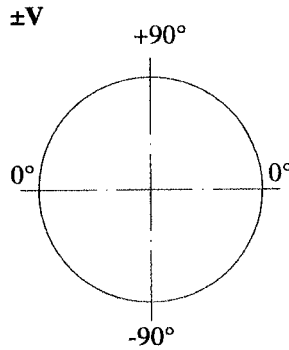
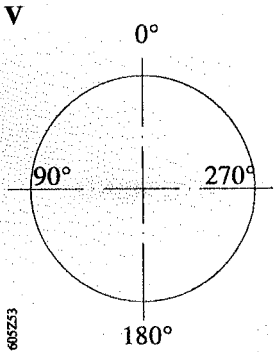

## Display number of decimal places (ROUND)



^*UNITS			
ANGLE	>	360S	
V-ANGL	>	V	
→ROUND	>	low	

- high = 81°45' 24" (1" Interval)

- med = 81°45' 25" (5" Interval)

- low = 81°45' 20" (10" Interval)



Confirm selection.

## Automatic switch-off (ON/OFF)



```

^CONFIG MENU
  REC DATA  →
  UNITS      →
  →ON/OFF   →
  
```



```

√*ON/OFF
→BEEP >      ON
BEP90°>     OFF
COMP >       ON
  
```

```

HZcomp>      ON
HZcoll>      ON
AUTOff>      ON
  
```



Scrolling menu items with arrow keys.



Selecting options.



Confirm settings and return to CONFIG MENU.

### BEEP

After each key touch an acoustic signal indicates the successful data entry. The signal can be switched OFF but is active again after switching on the total station again (ON).

### BEEP90°

Setting-out of right angles:

To simplify setting-out of right angles an acoustic signal (BEEP) can be activated.

Set BEP90° to ON and confirm.

BEEP pulsating  
+/- 4° (5gon)



TC600Z3

BEEP continuous  
+/- 30' (0.5gon)



TC600Z4

no signal  
+/- 30" (10mgon)



TC600Z5

## COMP

The acoustic warning signal and the error message (Error **58 TILT**) can be suppressed if the total station is not required to be properly levelled up (eg, on swaying platforms or ships).

For normal use set **COMP = ON**.

When switching the total station on the function is automatically set to **COMP = ON**.

### Transverse

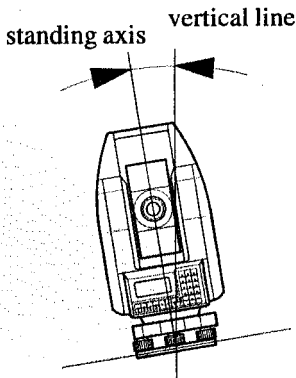

### Longitudinal

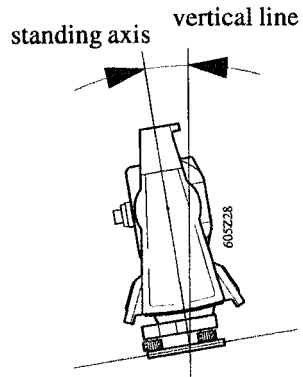

When the compensator is switched off (**COMP = OFF**) the vertical angle refers to the standing axis.

When the compensator is switched on (**COMP = ON**) the vertical angle refers to the vertical line (plumb line).

### Hzcomp (dual axis compensation)

Function **HZCOMP = ON** corrects the Hz-angles for the tilt of the standing axis.

Switching the compensator (**COMP**) off also sets the function **HZCOMP** to **OFF**.

When switching the total station on the function is automatically set to **HZCOMP = ON**.

## **HZcoll**

Corrects for the line-of-sight error:

If "HZcoll" is set to **ON** each measurement is corrected automatically for the line-of-sight error.

In case of setting **OFF** this correction is disabled.

## **AUToff**

Automatic switch-off:

In case of longer breaks (> 10 minutes) the setting "AUToff = ON" switches the instrument automatically off to save battery capacity.

"AUToff = OFF" disables the automatic switch off and leaves the instrument permanently on until manually switched off with the -key.

# TCTOOLS

The program TCTOOLS has the function of an external data manager for the TC600/TC800.

This program runs under MS-DOS.

TCTOOLS provides for data exchange between a PC and the TC600/TC800 and also includes a codelist manager to create and edit codelists.

The bidirectional data transfer and the conversion of the Leica GSI-format to ASCII and vice versa is supported by the individual functions.

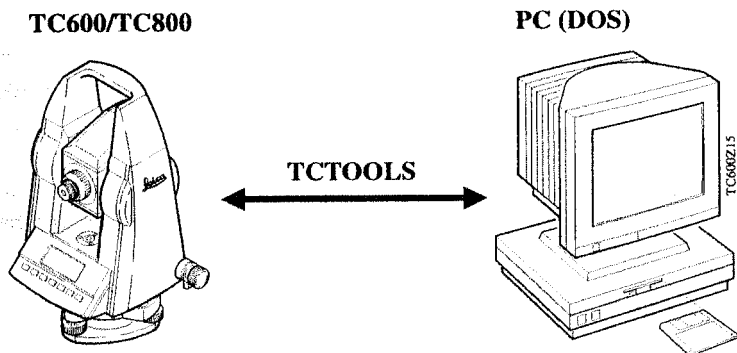

The program TCTOOLS consists of five main functions: **Codelist manager, Coordinate entry, Send data, Receive data, INFO/HELP**

## 1. Codelist manager

With this function it is possible to create and edit code lists and to transfer code lists between the PC and the TC600/TC800 fast and user-friendly.

The tabular input mask contains one CODE and five Info columns. Inputs are done likewise as in the Windows Excel program. Each code line must have a minimum of one entry in the code column else the complete code will not be accepted when saving the data.

Before a code is stored it must be packed, i.e. invalid and empty line will be eliminated.

## Example

No	Code	Info1	Info2	Info3	Info4	Info5
1	101	PART1	CORN	CENTRE	1	.....
2	102	.....	CORN	BOTT	35	.....
3	103	PART2	.....	BOTT	.....	.....
...						
50	150	PART8	.....	TOP	.....	.....

On the PC code lists can be created, edited, merged with each other and deleted. Transfer to the instrument is carried out via DATA TRANSFER, which also provides for receiving a codelist from the TC600/TC800 and deletion of a codelist on the TC600/TC800.

**2. Coordinate entry** The menu item COORDINATE ENTRY offers the input for point number, Easting, Northing and Height.

**3. Send data** Transfer coordinates from text-files to the TC and user specific format-files.

Coordinates from text-files can be transferred using three different options.

### *1. ASCII files (Data in lines)*

Sequential data structure with individual data elements separated by none numerical and none alphabetical characters. The complete data set contains one point number and the coordinates E (Easting), N (Northing) and H (Height), but at least data for E and N.

ASCII structure (data in lines):

```
PtNr      E          N          H
"100", "23456.678", "86543.456", "235.23"
-100*//23456.678*///-86543.456"" /235.2300
```

## 2. ASCII-Files (Data in columns)

Tabular data structure with individual data elements separated by spaces and none numerical and none alphabetical characters. One line must contain minimum values for E and N.

ASCII structure (data in columns):

PtNr	E	N	H
100	23456.678	86543.456	235.23
101	11025.025	45330.347	150.85

## 3. Leica GSI-Files

Extracts coordinates out of files in Leica format. These files can also contain measurements and coding information.

Only the point number and the related coordinates are extracted and transferred to the TC600/TC800.

## 4. Specific user formats

This option transfers user specific formats from the PC to the TC600/TC800. These specific formats are used to download data (please refer to *chapter "Other data formats"*).

**4. Receive data** Data can be transferred either in Leica GSI-format or in a user specific format.

*1. Leica GSI-formats*

Measurements:

Mask1 :	WI11	Pointnumber	(P)
	WI21	Horizontal angle	(Hz)
	WI22	Vertical angle	(V)
	WI31	Slopedistance	(sld)
	WI51	PPM+MM	(ppm+mm)
	WI87	Reflector height	(hr)
	WI88	Instrument height	(hi)

Mask2 :	WI11	Pointnumber	(P)
	WI21	Horizontal angle	(Hz)
	WI22	Vertical angle	(V)
	WI31	Slopedistance	(sld)
	WI81	Target Easting	(E)
	WI82	Target Northing	(N)
	WI83	Target Height	(H)
	WI87	Reflector height	(hr)

Coordinates (COORDS):

	WI11	Pointnumber	(P)
	WI81	Target Easting	(E)
	WI82	Target Northing	(N)
	WI83	Target Height	(H)

Example of a GSI-format

11....+00000101	81...0+23456678	82...0+86543456	83...0+00023523
11....+00000102	84...0+23456678	85...0+86543456	86...0+00023523
11....+00000103	84...0+23456678	85...0+86543456	86...0+00023523



## *2. User specific formats (Other formats)*

For data transmission from TC600/TC800 to the PC specially defined data formats can be used. These user specific output formats are created using specific software.

To download user specific formats, a format-file must be transferred to the TC600/TC800 first.

Once a user specific data format exists on the TC600/TC800, this format can be selected in TCTOOLS, which downloads the data from the data ranges COORDS, OBSERV in a specific defined format.

The user specific formats can be created as such, to suit the requirements for data processing best or to read the data out in a more readable format, such as a fieldbook format, etc.

For more information about other formats please refer to your nearest Leica representative.

## 5. INFO/HELP (On-line Help)

A complete On-line Help function is directly integrated into the TCTOOLS program and should be carefully read before using the TCTOOLS. All the possible functions of the program are described in detail by the Help texts of the TCTOOLS.

The file README.TXT on the diskette is supplied with each instrument.

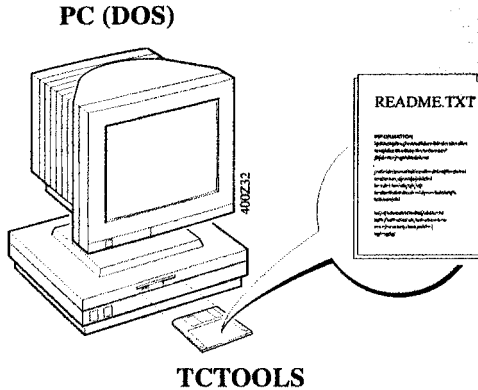

For data transfer the data cable (Part no. 563625) is needed. This cable is supplied with each instrument.

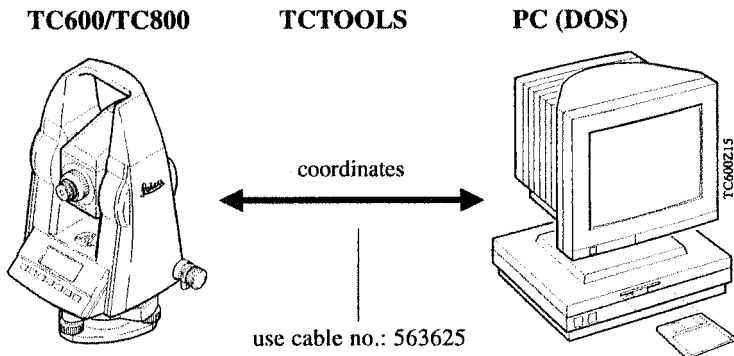

---

## ***Other data formats***

The instrument is designed to have flexibility in data output formats.

If you require specific data output formats, please consult your nearest Leica representative.

## **Communication PC-TC600/TC800**

For more detail information of command and data structures refer to the handbook 'Leica Instruments On-Line' which is available from your Leica representative.

---

### ***Set station coordinates***

Station coordinates can be transmitted from an external data recorder via RS232 interface at any time without having to reset the instrument. However, the instrument must be in the highest level (measuring mode).

Command structure:

(\_ = space char.)

Point number (PtNr)	PUT/11...+12345678_CRLF
Easting (Eo)	PUT/84...0+12345678_CRLF
Northing (No)	PUT/85...0+12345678_CRLF
Height (Ho)	PUT/86...0+12345678_CRLF
Instrument height (hi)	PUT/88...0+12345678_CRLF

---

### ***Set orientation***

A new direction can be transmitted at any time provided that the instrument is in the measuring display mode.

Command structure: (\_ = space char.)

Hz PUT/21...2+12345678\_CRLF



---

## Setting-out

	Command structure
Call the function	(- = space char.) 'SETOUT' (setting-out)
Point number (PtNr)	PUT/11...+12345678_CRLF
Hz-angle to be set out:	PUT/24...2+12345678_CRLF
Horizontal distance to be set out:	PUT/34...0+12345678_CRLF
Height to be set out:	PUT/83...0+12345678_CRLF

Return to data transfer (c for a new point)  
Terminates program function "setting-out" x

After the required 4 data lines are transmitted to the TC600/TC800 unit, the display changes automatically to the mode showing the divergence between specified direction and present instrument direction.

After distance measurement (**DIST**) the difference between the computed and measured horizontal distance as well as the difference in height between the instrument position and the setting-out point are displayed. At the same time, the keys  and  are active to send data to an external data recorder. Measurements and data recordings can also be activated from an external data recorder.

## Checking and adjusting

### *Tripod*

The connections between metal and timber components must always be firm and tight.

- Tighten the Allen screws (2) moderately from time to time, as necessary.
- The same key is also suitable for adjusting the articulated joints on the tripod head (1). Tighten these just enough to keep the tripod legs open when you lift it off the ground.

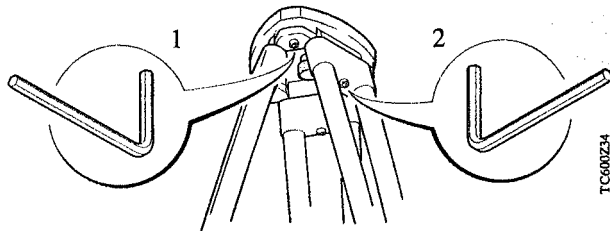

### *Circular level*

Level-up the instrument in advance with the electronic level. The bubble must be centered. If it extends beyond the circle, use the allen key supplied to center it with the adjustment screws.

After adjustment no screw must be loose.

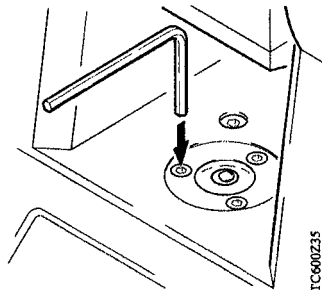

---

***Circular level on the  
tribrach***

Level the instrument and then remove it from the tribrach. If the bubble is not centred, adjust it using the adjusting pin in connection with the two cross-headed adjustment screws.

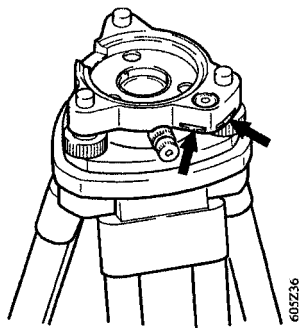

Turning the adjustment screws:

- to the left: the bubble approaches the screw
- to the right: the bubble goes in the other direction.

After adjustment no screw must be loose.

## ***Optical plummet***

Check the optical plummet of the tribrach at regular intervals. Any deviation of the line-of-sight from the vertical axis of the instrument causes a centering error.

### **Checking by plumb-bob:**

Set up and level up the instrument (with plumb-bob) on the tripod. Mark the ground point. Remove the plumb-bob. Check that the crosshairs of the optical plummet intersect at the ground point. The accuracy achievable is about 1mm.

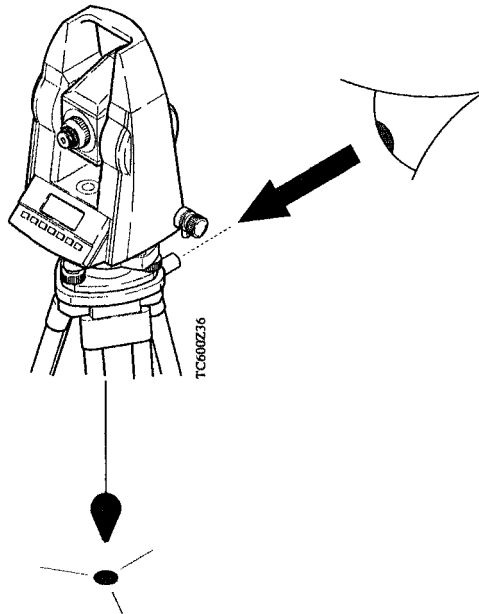



### Checking by turning the tribrach:

1. Level up the instrument using the electronic level.  
Mark the ground point. Using a pencil, mark the outline of the tribrach on the tripod plate.
2. Turn the tribrach  $120^\circ$ , fit it into the outline, level up the instrument, and again mark the ground point.
3. Repeat this procedure in the third position.

If the three points do not coincide, adjust the crosshairs of the tribrach to the center of the triangle formed by the three ground points.

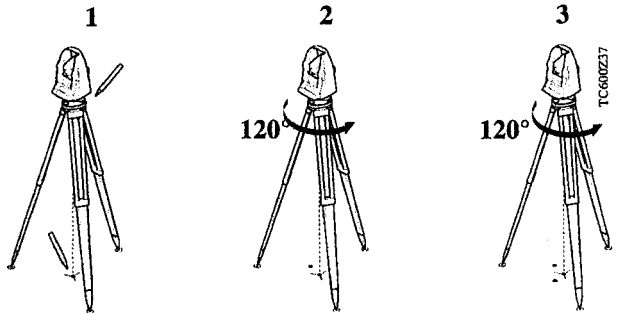

### Adjustments:

Use a screwdriver to turn the two set screws alternately by the same small amount in order to center the crosshairs on the marked ground point.

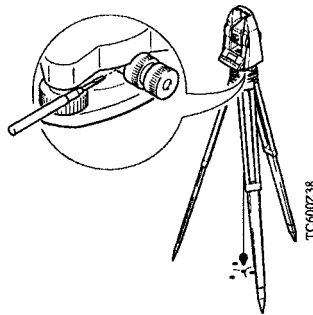

## Care and transport

### Transport:

When dispatching the equipment, always use the complete original Leica packaging (case and cardboard box). When transporting the equipment in the field, always make sure to:

- either carry the instrument in its original transport case or
- carry the tripod with its legs splayed across your shoulder, keeping the **attached instrument upright**.

TC800

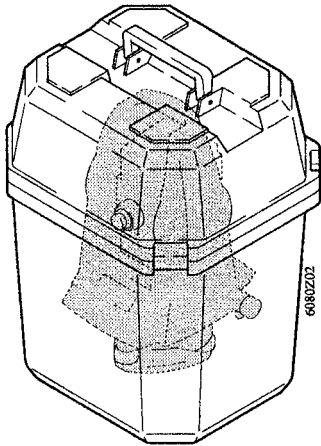

TC600

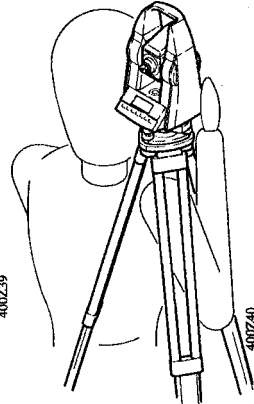
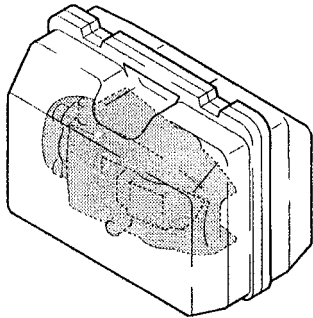

### Cleaning and drying:

Objective, eyepiece and prisms

- blow dust off lenses and prisms
- Never touch the glass with fingers
- Use only a clean, soft and lint-free cloth for cleaning. If necessary, moisten the cloth with pure alcohol.

Use no other liquids; these may attack polymer components.



**When storing the equipment, particularly in summer and inside a vehicle, take the storage temperature limits (-40°C to + 70°C / -40°F to +158°F) into account.**

**Cables and plugs:**

Keep plugs clean and dry. Blow out any dirt lodged in the plugs of the connecting cables.

If you unplug connecting cables during the measurement, you may lose data.

Always switch off the instrument before removing the connecting cables.

**Fogging of prisms:**

Reflector prisms that are cooler than the ambient temperature tend to fog. It is not enough to simply wipe them. Keep them for some time inside your jacket or in the vehicle to allow them to adjust to the ambient temperature.

**Storage:**

If the instrument becomes wet, leave it unpacked. Wipe down, clean, and dry the instrument (at not more than 40 °C/ 108°F), transport case, foam inserts, and accessories. Pack up the equipment only when it is perfectly dry.

## **Battery charging**



### **WARNING:**

Use a battery charger in a dry room only, never outdoors. Charge batteries only at an ambient temperature between 10°C and 30°C ( 50°F to 86°F ). We recommend a temperature of 0°C to +20°C (32°F to 68°F) for storing the batteries.

---

### **Battery chargers GKL22 and GKL23**

#### **Charger GKL22:**

The charger outputs constant current and charges a NiCd battery within 14 hours. The charging procedure starts automatically whenever a battery is connected to the charger and a red control lamp indicates a fully charged battery.

Charging batteries with 2 pole plug requires an adapter cable.

#### **Fast charger GKL23:**

Fast charging with the GLK23 is possible with Leica NiCd-batteries equipped with a 5-pole plug. Fast charging requires 1.5 to 5 hours depending on the battery capacity.

Leica batteries with 2-pole plugs can be charged using an adapter cable - this charging procedure will take 14 hours.

Connecting 2 batteries at the same time, will charge the batteries sequentially. Batteries with fast charging capabilities are priority.

Charging modes and status of the GKL23 is shown by three color-LEDs.

For more information about use, functions and displays refer to the user manual of the GKL23.

---

## **Battery chargers** **GKL12 and GKL14**

If you already own one of these battery chargers, we recommend:

- the charger GKL12 for charging the total station's battery insert (2-pole charging plug) and the GEB70 compact battery.
- For the GEB71 universal battery, use a GKL14 charger.

Before you use new batteries for the first time, charge them for 20 to 24 hours. This also applies to batteries that have not been used for several months. NiCd batteries reach full capacity after two or three normal cycles each of a 14-hour charge followed by a full discharge

If battery performance drops noticeably, run one or two full cycles, i.e. charge for 14 hours and allow to discharge until the instrument displays "Battery low".

Leave flat batteries to charge for fourteen hours. If you do not know a battery's state of charge, also leave it to charge for fourteen hours.

Set the battery charger's voltage selector to your AC mains voltage, **115V** or **230V**. Plug in the charger to the mains. The green indicator lamp should light. If it does not light, there is a power cut or the mains cable or charger is faulty.

Connect the battery to the charger. The red charging indicator should light. If it does not, the battery is not charging, i.e. the battery cable is faulty or the battery fuse has blown and should be replaced. On the GKL12, you may not have started the timer or it may have stopped at the end of the charging period.

---

## ***Safety directions***

The following directions should enable the person responsible for the TC600/TC800, and the person who actually uses the instrument, to anticipate and avoid operational hazards.

The person responsible for the instrument must ensure that all users understand these directions and adhere to them.

---

### ***Intended use of instrument***

#### **Permitted uses**

The TC600/TC800 electronic total stations are intended to the following applications:

- Measuring horizontal and vertical angles
- Measuring distances
- Recording measurements
- Computing by means of application software
- Visualising the aiming direction (with EGL1 Guide Light)

#### **Adverse uses**

- Use of the total station without previous instruction
- Use outside of the intended limits
- Disabling safety systems and removal of hazard notices
- Opening the instrument using tools (screwdriver, etc.), unless this is specifically permitted for certain functions
- Modification or conversion of the instrument
- Use after misappropriation

- Use with accessories from other manufacturers without the prior express approval of Leica
- Aiming directly into the sun
- Inadequate safeguards at the measuring station (e.g. when measuring on roads, etc.)



**WARNING:**

Adverse use can lead to injury, malfunction, and damage.

It is the task of the person responsible for the instrument to inform the user about hazards and how to counteract them. The TC600/TC800 total stations are not to be used until the user has been properly instructed how to use them.

---

***Limits of use***

**Environment:**

Suitable for use in an atmosphere appropriate for permanent human habitation: not suitable for use in aggressive or explosive environments. Use in rain is permissible for limited periods.

*Refer to section "Technical data".*

**Area of responsibility for the manufacturer of the original equipment Leica Geosystems AG, CH-9435 Heerbrugg** (hereinafter referred to as Leica):  
Leica is responsible for supplying the product, including the user manual and original accessories, in a completely-safe condition.

**Responsibilities of the manufacturers of non-Leica accessories:**

The manufacturers of non-Leica accessories for the TC600/TC800 electronic total station are responsible for developing, implementing and communicating safety concepts for their products, and are also responsible for the effectiveness of those safety concepts in combination with the Leica product.

**Responsibilities of the person in charge of the instrument:**



**WARNING:**

The person responsible for the instrument must ensure that it is used in accordance with the instructions. This person is also accountable for the training and deployment of personnel who use the instrument and for the safety of the equipment when in use.

The person in charge of the instrument has the following duties:

- To understand the safety instructions on the product and the instructions in the user manual.
- To be familiar with local regulations relating to accident prevention
- To inform Leica immediately if the equipment becomes unsafe.



**WARNING:**

The absence of instruction, or the inadequate imparting of instruction, can lead to incorrect or adverse use, and can give rise to accidents with far-reaching human, material, financial and environmental consequences.

**Precautions:**

All users must follow the safety directions given by the manufacturer and the directions of the person responsible for the instrument.

**WARNING:**

The charger must not be used in damp or inclement conditions. If moisture penetrates the charger, the user may receive an electric shock.

**Precautions:**

Use the charger only indoors, in dry rooms. Protect it from damp. If the charger is damp, do not use it.

**WARNING:**

If you open the charger, either of the following actions may cause you to receive an electric shock:

- Touching live components
- Using the charger after incorrect attempts to carry out repairs

**Precautions:**

Do not open the charger yourself. Only a Leica-approved service technician is entitled to repair it.

**CAUTION:**

Watch out for erroneous distance measurements if the instrument is defective or if it has been dropped or has been misused or modified.

**Precautions:**

Periodically carry out test measurements and perform the field adjustments indicated in the user manual (*refer to section "Determine instrument errors" and "Checking and adjusting"*), particularly after the instrument has been subjected to abnormal use and before and after important measurements.

**DANGER:**

Because of the risk of electrocution, it is very dangerous to use reflector poles and extensions in the vicinity of electrical installations such as power cables or electrical railways.

**Precautions:**

Keep at a safe distance from electrical installations. If it is essential to work in this environment, first contact the safety authorities responsible for the electrical installations and follow their instructions.

**WARNING:**

By surveying during a thunderstorm you are at risk from lightning.

**Precautions:**

Do not carry out field surveys during thunderstorms.

**CAUTION:**

Be careful not to point the instrument directly towards the sun, because the telescope functions as a magnifying lens and can injure your eyes or damage the internal components of the EDM and EGL1 Guide Light.

**Precautions:**

Avoid pointing the telescope directly at the sun.

**WARNING:**

During target recognition or set out procedures there is a danger of accidents occurring if the user does not pay attention to the environmental conditions around or between the instrument and the target (e.g. obstacles, excavations or traffic).

**Precautions:**

The person responsible for the instrument must make all users fully aware of the existing dangers.

**WARNING:**

Inadequate securing of the surveying site can lead to dangerous situations, for example in traffic, on building sites and at industrial installations.

**Precautions:**

Always ensure that the survey site is adequately secured. Adhere to the regulations governing accident prevention and road traffic.

**CAUTION:**

If a target lamp accessory is used with the instrument the lamp's surface temperature may be extreme after a long working period. It may cause pain if touched. Replacing the halogen bulb before the lamp has been allowed to cool down may cause burning to the skin or fingers.

**Precautions:**

Use appropriate heat protection such as gloves or woollen cloth before touching the lamp, or allow the lamp to cool down first.

**WARNING:**

If computers intended for use indoors are used in the field, there is a danger of electric shock.

**Precautions:**

Adhere to the instructions given by the computer manufacturer with regard to field use in conjunction with Leica instruments.

**CAUTION:**

During the transport or disposal of charged batteries it is possible for inappropriate mechanical influences to constitute a fire hazard.

**Precautions:**

Before transporting or disposing of equipment, discharge the battery (e.g. by running the instrument in tracking mode until the batteries are exhausted or discharging with the GKL23 battery charger).

**CAUTION:**

If the accessories used with the instrument are not properly secured, and the equipment is subjected to mechanical shock (e.g. blows, falling etc.), the equipment may be damaged or people may sustain injury.

**Precautions:**

When setting-up the instrument, make sure that the accessories (e.g. tripod, tribrach, connecting cables, etc.) are correctly adapted, fitted, secured and locked in position.

Avoid subjecting the equipment to mechanical shock. Never position the instrument on the tripod baseplate without securely tightening the central fixing screw. If the screw is loosened always remove the instrument immediately from the tripod.

**WARNING:**

If the equipment is improperly disposed of, the following can happen:

- If polymer parts are burnt, poisonous gases are produced which may impair health.
- If batteries are damaged or are heated strongly, they can explode and cause poisoning, burning, corrosion or environmental contamination.
- By disposing of the equipment irresponsibly you may enable unauthorized persons to use it in contravention of the regulations, exposing themselves and third parties to the risk of severe injury and rendering the environment liable to contamination.
- Leakage of silicone oil from the compensator can damage the optical and electronic subassemblies.

**Precautions:**

Dispose of the equipment appropriately in accordance with the regulations in force in your country. Always prevent access to the equipment by unauthorized personnel.

---

## **Laser classification**

---

### ***Integrated distancer (EDM)***

The EDM module built into the total station produces an invisible infrared beam which emerges from the telescope objective (*refer section "Technical data"*). The product is a Class 1 LED product in accordance with:

- IEC 825-1 : 1993 "Radiation safety of laser products".
- EN 60825-1 : 1994 "Radiation safety of laser products".

Class 1 LED products are safe under reasonably foreseeable conditions of operation and are not harmful to the eyes provided that the products are used and maintained in accordance with the instructions.

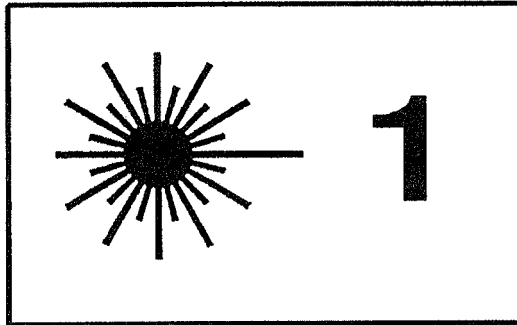

#### **TC600**

Beam divergence:	2.5 mrad
Impulse duration:	10 ns
Maximum power output:	200 $\mu$ W peak
Measurement uncertainty:	$\pm 5\%$

## TC800

Beam divergence:	2.02 mrad
Impulse duration:	10 ns
Maximum power output:	360 $\mu$ W peak
Measurement uncertainty:	$\pm 5\%$

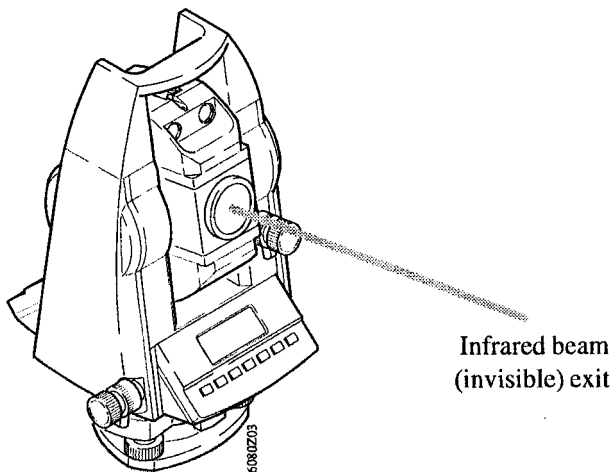

## Guide Light EGLI

The integrated Guide Light option (for TC800 series) produces an visible LED light beam from the upper front side of the telescope.

The product is a Class 1 LED product \*) in accordance with:

- IEC 825-1 : 1993 "Radiation safety of laser products".
- EN 60825-1 : 1994 "Radiation safety of laser products".

\*) within the specified working range > 5 m (> 16 ft).

Class 1 LED products are safe under reasonably foreseeable conditions of operation and are not harmful to the eyes provided that the products are used and maintained in accordance with the instructions.



### CAUTION:

Use the Guide Light option within the specified range (at a distance of > 5 m (> 16 ft) from the telescope).

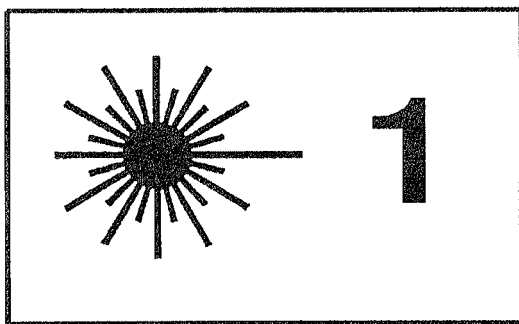



Flashing LED	Yellow	Red
Beam divergence	2.4 °	2.4 °
Impulse duration	2 x 35 ms	35 ms
Maximum power output	0.55 mW	1.2 mW
Measurement uncertainty	± 5 %	± 5 %

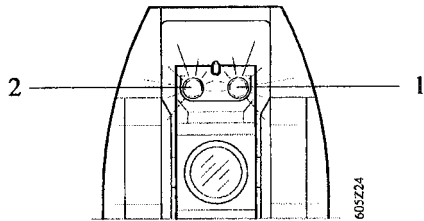

- 1 Exit for flashing red LED
- 2 Exit for flashing yellow LED

---

## ***Electromagnetic acceptability***

The term "electromagnetic acceptability" is taken to mean the capability of the instrument to function correctly in an environment where electromagnetic radiation and electrostatic discharges are present, and without causing electromagnetic disturbances in other equipment.



### **WARNING:**

Electromagnetic radiation can cause disturbances in other equipment.

Although the total station meets the strict regulations and standards which are in force in this respect, Leica cannot completely exclude the possibility that other equipment may be disturbed.



### **CAUTION:**

There is a risk that disturbances may be caused in other equipment if the total station is used in conjunction with accessories from other manufacturers (e.g. field computers, personal computers, portable radios, non-standard cables, external batteries etc.).

**Precautions:** Use the equipment only with accessories from Leica. When combined with total stations, the strict requirements stipulated by the guidelines and standards are assured. When using computers and portable radios, pay attention to the information provided by the manufacturer., regarding electromagnetic acceptability.

**CAUTION:**

Disturbances caused by electromagnetic radiation can result in the tolerance limits for measurements being exceeded.

Although the total station meets the strict regulations and standards which are in force in this connection. Leica cannot completely exclude the possibility that the total station may be disturbed by very intense electromagnetic radiation, for instance near radio transmitters, portable radios, diesel generators etc.

**Precautions:** Check the plausibility of results obtained under these conditions.

**WARNING:**

If the total station is operated with cables attached at only one of their two ends (e.g. external power supply cables, interface cables, etc.), the permitted level of electromagnetic radiation may be exceeded and the correct functioning of other instruments may be impaired.

**Precautions:** While the total station is in use, cables (e.g. instrument to external battery, instrument to computer, etc.) must be connected at both ends.

---

***FCC statement  
(applicable in U.S.)***

**WARNING:**

This equipment has been tested and found to comply with the limits for a Class B digital device, pursuant to part 15 of the FCC rules.

These limits are designed to provide reasonable protection against harmful interference in a residential installation.

This equipment generates, uses and can radiate frequency energy and, if not installed and used in accordance with the instructions, may cause harmful interference to radio communications. However, there is no guarantee that interference will not occur in a particular installation. If this equipment does cause harmful interference to radio or television reception, which can be determined by turning the equipment off and on, the user is encouraged to try to correct the interference by one or more of the following measures:

- Reorient or relocate the receiving antenna.
- Increase the separation between the equipment and the receiver.
- Connect the equipment into an outlet on a circuit different from that to which the receiver is connected.
- Consult the dealer or an experienced radio/TV technician for help.



**WARNING:**

Changes or modifications not expressly approved by Leica for compliance could void the user's authority to operate the equipment.

***Product labeling***

This device complies with part 15 of the FCC Rules. Operation is subject to the following two conditions:  
(1) This device may not cause harmful interference, and  
(2) this device must accept any interference received, including interference that may cause undesired operation.

*This device complies with part 15 of the FCC Rules. Operation is subject to the following two conditions:  
(1) This device may not cause harmful interference, and (2) this device must accept any interference received, including interference that may cause undesired operation.*

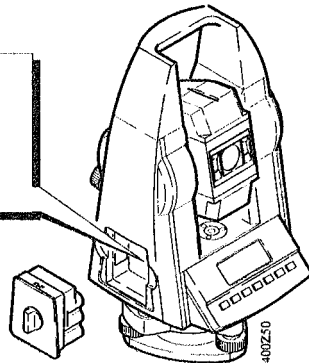

## ***Error reports and warnings***

	<b>Error report</b>	<b>Cause</b>	<b>Remedy</b>
02	Full	Internal memory is full	Clear internal memory
03	Invalid Value	Non-valid value was entered	Enter a valid value
12	Battery Empty	Battery exhausted	Change battery
19	Temperature	The inside of the instrument is too hot or too cold	Cool or warm the instrument
21	Parity Error	Parity error at interface	Inspect cables and interface parameters
22	RS232 Timeout	The system is receiving no response from the interface	Inspect cables, and functionality of external recording device. Inspect baud rate
24	RS232 Overflow	The data are being transmitted too quickly	Repeat using a lower baud rate
44	Value >1 gon	V-index measured, or line-of-sight error, is > 54' (> 1 gon)	Redetermine value, or contact service department
50	Angle Error	Measuring error angle scanning	Contact service department
51	System error	System error in compensator	If fault re-occurs, contact service department
55	EDM Signal	EDM signal faint, absent or distorted	Inspect pointing. Check that distance is not too great

	<b>Error report</b>	<b>Cause</b>	<b>Remedy</b>
56	EDM System	System error in EDM	If error occurs repeatedly, contact service department
58	TILT	Total station not levelled	Level the instrument or re-adjust the V-index, which adjusts also the electronic level
	Invalid Data	Invalid data for transfer to TC600/TC800	Press  - key
82	Out of Range	For determination of index- or collimation error, V-angle is more than $\pm 6^\circ$ (6.6666 gon) off the horizontal plane	Bring target point within tolerance range
9x		System defective	Contact service department

	<b>Warning</b>	<b>Cause</b>	<b>Remedy</b>
09	PtNr Overflow	PtNr outside the upper and lower limits	Enter a new PtNr max. 8 digits
10	PtNr.Not Incr.	PtNr. cannot be incremented	Change PtNr. manually
12	Battery Low	The battery is practically flat (Level=0)	Change battery or connect an external battery

## Technical data

### Distance measurement

RANGE [m] (ft)	TC600	TC800
Atmospheric conditions	1 prism / 3 prisms	1 prism / 3 prisms
poor 1)	800 (2600) / 1000 (3300)	1200 (3900) / 1500 (4900)
fair 2)	1100 (3600) / 1600 (5200)	2500 (8200) / 3500 (11500)
excellent 3)	1300 (4300) / 2000 (6500)	3500 (11500) / 5000 (16400)

- 1) very hazy, visibility 3 km, or strong sunlight and heavy heat shimmer
- 2) light haze, or some clouds and slight heat shimmer
- 3) overcast, no haze, visibility 30 km, no heat shimmer

Standard deviation	TC600	TC800
Fine mode	3mm + 3ppm	2mm + 2ppm
Rapid mode	- - -	3mm + 2ppm
Tracking	10mm + 3ppm	5mm + 2ppm

Measurement time [sec]	TC600	TC800
Fine mode	4	2.5
Rapid mode	- - -	0.9
Tracking	0.5	0.3

## Angle measurement

	TC600	TC800
Standard deviation ["] (mgon)	5 (1.5)	3 (1)
Display resolution ["] (mgon)	10", 5", 1" (3, 1, 0.2)	10", 5", 1" (3, 1, 0.2)

- absolute, continuous, updates each 0.3 sec
- Units selectable:  
400 gon; 360° decimal; 360° sexagesimal;  
V%, ±V, V

## Telescope

	TC600	TC800
Objectiv lens-Ø [mm] (in)	28 (1.1)	42 (1.7)
Shortest focusing distance [m] (ft)	2 (6.6)	1.7 (5.6)
Field of view	1°30' (26 m/km)	1°30' (26 m/km)
Magnification	28x	30x

- Topics**
- Level sensitivity : Circular level: 4'/2mm  
Electronic level: 5" (1.5 mgon)
- Optical plummet: In tribrach, focusable,  
Magnification 2x  
Accuracy: 0.5mm/1.5m
- Compensator : liquid, dual axes  
Working range: ±5' (±0.1 gon)  
Accuracy: ±2" (±0.6 mgon)
- Display : Liquid crystal  
4 lines of 16 characters
- Keyboard : TC600: 1 Keyboard, alphanumerical  
TC800: 2 Keyboards,  
alphanumerical
- EGL1 (optional): working range: 150m (500 ft)  
divergence: 12m (40ft) at 100m (330ft)



Automatic corrections : • Hz-collimation  
 • vertical index  
 • earth curvature and refraction  
 • standing axis tilt

**Features** Built-in programs : • Station set, Orientation set  
 • Free station  
 • Set out  
 • Tie distance  
 • Calculate Area  
 • Rapid measurement

**Special** Data manager : powerful data management system "Input, find, view, delete points or complete data ranges"

**Data memory** Internal storage : 1300 data sets for measurements or 1800 points with coordinates  
 External interface : RS232

**Dimensions** Height, length, width : TC600: 344 x 180 x 194 mm  
 TC800: 344 x 225 x 194 mm  
 Instrument weight (incl. battery) : TC600: 4.3 kg (9.5 lbs)  
 TC800: 5.6 kg (12.3 lbs)  
 Tribrach weight : GDF11: 0.6 kg (1.3 lbs)  
 GDF12: 0.7 kg (1.5 lbs)  
 GDF21: 0.77 kg (1.7 lbs)  
 GDF22: 0.85 kg (1.9 lbs)

**Power supply**

<b>Operating life of batteries</b>	<b>GEB77 battery module</b>	<b>GEB70 compact battery</b>
Voltage / capacity	12V / 0.6A	12V / 2.0A
No. of measurements with distance	approx.	approx.
TC600	700	1400
TC800	800	2000
Operating time [h]		
- angle meas. only	10	30
- angle and distance	5	12
Recharging time [h]	1	1.5
Weight [kg]	0.2	0.9

**Temperature range**

Operation : -20°C(-4°F) to +50°C(122°F)

Storage : -40°C(-40°F) to +70°C(158°F)

**Atmospheric correction in ppm with °C, mb, H (meter)  
at 60% relative humidity**

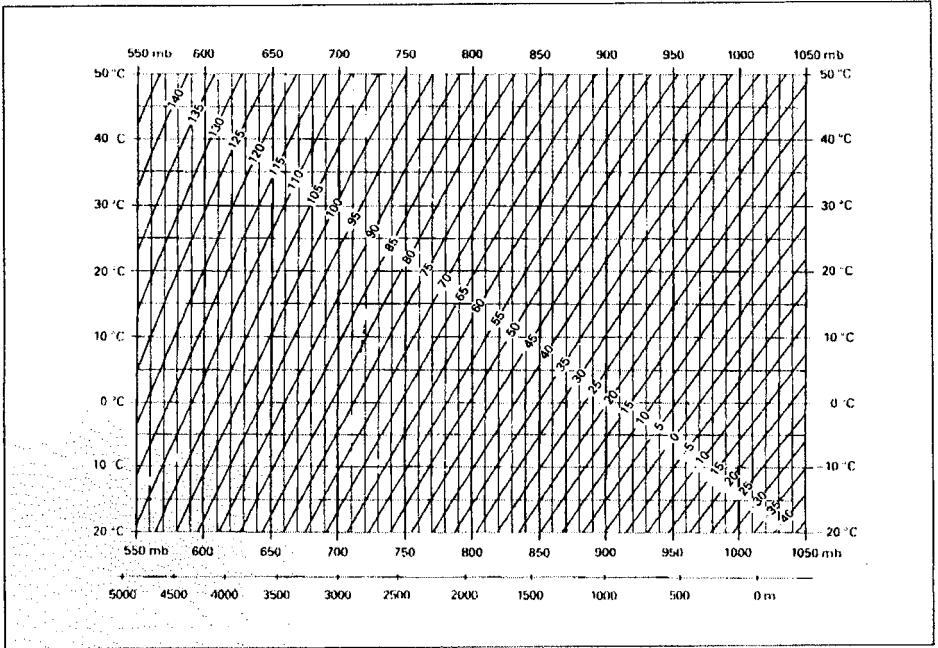

**Atmospheric correction in ppm with °F, inch Hg, H (Feet)  
at 60% relative humidity**

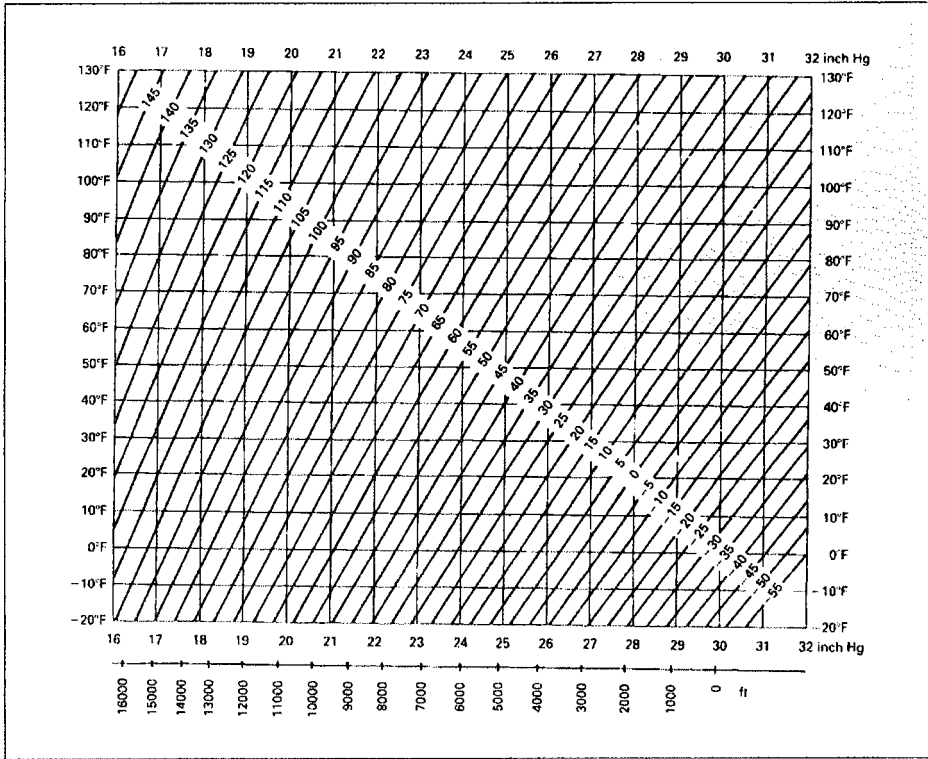

# Index

---

## A

AC mains voltage	107
Adjustments	103
Adverse uses	108
Alphanumeric entry mode	58
Alphanumeric entry of point number	58
ANGLE	86
Angle measurement	126
Area computation	51
ASCII	91, 92
Atmospheric correction	129, 130
Atmospheric pressure	77
Automatic corrections	127
Azimuth	48

---

## B

Battery	75
Battery chargers	106, 107
Battery status	75

---

## C

Cables	105
Calc Area	51
Charger	106
Charging	13
Checking	100
Circular level	100
Cleaning	104
Code input	64
Codelist	91
Codes	63
Columns	93
Communication	98
Compensator	126
Configuration	77
Contrast	82
Coordinate entry	63
Coordinates	92
Cursor	18

---

**D**

Data and recording parameter	83
Data management	62
Data manager	127
Data transfer	91
DATOUT	83
Delete	68, 69
Dimensions	127
Display	18, 126
Display contrast	82
Display number of decimal places	87
Display of stored data	67
Display symbols	23
Display-masks	61
Displaying instrument parameters	75
DIST	86
Distance measurement	24, 125
Download	95
Drying	104
DSP	61

---

**E**

EDM	70, 116
EDM Signal	76
EGL1	126
Electromagnetic acceptability	120
Electronic level	16, 80
Entering point number	57
Entering reflector height	58
Error reports	123
External batteries	13

---

**F**

Fast charger	106
FIND	65
Fogging of prisms	105
FORMAT	85
Free Station	41

---

**G**

GSI-format	91
Guide Light	72, 118

---

<b>H</b>	Hazards of use	111
	Height difference	48
	Height offset	47
	Hidden points	25
	Horizontal circle	59
	Hz	59, 60

---

<b>I</b>	Indication	44
	INPUT	63
	Input of coordinates	63
	Instrument errors	79
	Instrument temperature	75
	Intended use of instrument	108
	Interface	18
	Internal battery	13
	Internal memory	84
	Internal storage	127
	IntMem	39, 49
	Introduction	8

---

<b>K</b>	Key functions	19
	Keyb	37, 39, 47, 49
	Keyboard	18, 126

---

<b>L</b>	Laser classification	116
	Level sensitivity	126
	Level up	16
	Limits of use	109
	Line-of-sight error	81

---

<b>M</b>	MASK	85
	Mean height above sea level	77
	Measure and record	23
	Menu tree	20, 21
	Meteorological correction	77

---

**O**

Offset	25
On-Line commands	98
OnLine	49
Operating concept	17
Optical plummet	102, 126
Orange keys	18
ORIENTATION	39
Orientation by PC	98
Orientation correction	44
Orientation of horizontal circle	39

---

**P**

Permitted uses	108
Plugs	105
Plumb-bob	102
Pointing	24
Power supply	128
ppm values	77
Prism constant	78

---

**R**

Rapid measurement	54
REC DATA	83
Recording	84
Reflector height	57
Relative humidity	129, 130
Responsibilities	110
Retro tapes	73
ROUND	87
RS232	85



---

**S**

Safety directions	108
Searching	65
SET	57
SET PtNr/hr	57
Set station coordinates by PC	98
Set-up	14
Setout	46
Setting out	46
Setting-out by PC	99
Setting-out of right angles	88
Settings	57
Slope	87
Station Coord	36
Station coordinates	36
Status	75
Storage	105
Storage temperature limits	105
Switch-off	88

---

**T**

Target points	43
TCTOOLS	91
Technical data	125
Telescope	126
Temperature	77
Temperature range	128
Testing the instrument	75
Tie Distance	48
Tracking mode	26, 54
Tribrach	101
Tripod	100
Turning the tribrach	103

---

**U**

UNITS	86
Units for distance measurement	86
Unpacking	11
User Programs	34

---

<b>V</b>	V-Angle	87
	Vertical angle	87
	Vertical index error	79
	Vertical-angle indication	87
	VIEW	67

---

<b>W</b>	Warning	124
	White keys	18
	WI-codes	94

---

<b>Z</b>	Zenith angle	87
----------	--------------	----

*Leica Geosystems AG,  
Heerbrugg, Switzerland  
has been certified as being  
equipped with a quality  
system which meets the  
International Standard of  
Quality Management  
and Quality Systems  
(ISO standard 9001)*



*Total Quality Management.  
Our commitment to total  
customer satisfaction*

*Ask your local Leica agent for  
more information about our  
TQM program*





664904-2.1.1

Printed in Switzerland · Copyright Leica Geosystems AG,  
Heerbrugg, Switzerland 1998  
Original text

*Leica*

*Leica Geosystems AG  
Geodesy  
CH-9435 Heerbrugg  
(Switzerland)*

*Phone +41 71 727 31 31*

*Fax +41 71 727 46 73*

*[www.leica.com](http://www.leica.com)*