

TPS - System 1000

System

Version 2.2
English

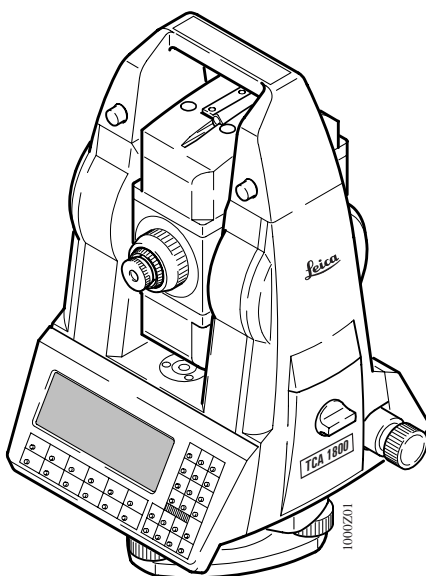

USER MANUAL

Leica

**Congratulations on your purchase of a
TPS - System 1000.**



This manual contains important safety directions (*refer to chapter "Safety directions"*) as well as instructions for setting up the instrument and operating it. Read carefully through the User Manual before you switch on the instrument.

TPS - System 1000

System

Electronic theodolites and total stations

Product identification

The instrument model and the serial number of your product are indicated on the label in the battery compartment.

Enter the model and serial number in your manual and always refer to this **information** when you need to contact your **agency** or authorized **service workshop**.

Type: _____ Serial number: _____

Symbols used in this manual

The symbols used in this User Manual have the following meanings:



DANGER:

Indicates an imminently hazardous situation which, if not avoided, will result in death or serious injury.



WARNING:

Indicates a potentially hazardous situation or an unintended use which, if not avoided, could result in death or serious injury.



CAUTION:

Indicates a potentially hazardous situation or an unintended use which, if not avoided, may result in minor or moderate injury and / or appreciable material, financial and environmental damage.



Important paragraphs which must be adhered to in practice as they enable the product to be used in a technically correct and efficient manner.

Leica TPS-System 1000 Registration Card

Part 1

This card comprises two parts:

- Retain part 1 for your records
- Return part 2 to Leica Geosystems AG, CH-9435 Heerbrugg, Switzerland - Your name and address, the serial number of the instrument will be registered and you will receive confirmation of this registration. - Your local Leica representative will also receive confirmation

Act immediately

Complete and return part 2 to ensure that you receive software support. If you do not, you will not be registered and Leica will not be able to provide the support that you may need.

Software support

Once your name, your address and the serial number of the instrument are registered Leica will, at its discretion, provide you with the following support free of charge:

- Instructions about any corrections and/or modifications that are necessary for the correct functioning of the software as supplied to you.
- Disks containing corrections and/or modifications necessary for the correct functioning of the software as supplied to you.

Limit to software support

Once your name, address and instrument are registered Leica undertakes to provide reasonable support for the software as supplied to you. This software support does NOT extend to upgrades to new versions of software as may be introduced by Leica in the future.

Upgrade, enhancement, and exchange programs

Only registered users will receive automatic notification of possible future product enhancements.

Change of address

Should you change your address after registering for software support, please write to Leica Geosystems AG, CH-9435 Heerbrugg, Switzerland, fax no +41 71 727 46 73, giving details of your new address, telephone and telefax numbers.

Part 2

Please fill in the coupon below and send the original or a copy to the address on the other side or fax it to +41 71 727 3605.

7



Instrument type	Software versions:
Serial number	System SW V
Date purchased	Standard programs:
Company name / Address <i>(Please write clearly or use the Company stamp)</i>	Orientation V
	Resection V
	Stakeout V
	Tie distance V

Contact persons

Telephone

Telefax

7

8



Leica

Software-Support Registration
Geodesy Division (3681)
Leica Geosystems AG
CH-9435 Heerbrugg
Switzerland

View of chapters

Contents	10	CO
Introduction	15	IN
Instrument descriptions	17	ID
Preparing to measure, setting up	22	PM
First steps	31	FS
System concept	37	SC
Operating concept	41	OC
Instrument operation	61	IO
Automatic Target Recognition	143	AR
RCS (Remote Controlled Surveying)	161	RC
Guide Light EGL1	173	EG
Checking and adjusting	175	CA
Care and transport	201	CT
Battery charging	203	BC
Data format	205	DF
Safety directions	219	SD
Technical specifications	240	TS
Index	249	IX

Introduction	15
Area of applicability of this User Manual	16
Instrument descriptions	17
T - Version	17
TM - Version	18
TC - Version	19
TCM - Version	20
TCA - Version	21
Preparing to measure, setting up	22
Unpacking	22
Charging battery	23
Preparing to measure T- and TM - Versions	23
Preparing to measure with TC, TCM and TCA - versions	25
Setting up the instrument	26
Tribrach with optical plummet	26
Tribrach without optical plummet	28
Laser plummet in instrument	29
First steps	31
Switching on the instrument	31
Levelling-up with the electronic bubble	32
Installing a distancer (EDM)	33
Measuring distances and angles	35
Summary of the first steps	36
System concept	37
Software architecture	37
Memory concept and data flow	38
Operating modes	39
GeoBasic	40

Operating concept	41
Display / keyboard	42
Types of dialog	43
Program-selection dialog	43
Input/output dialog	44
Character field	46
Numeric field	49
List field	50
Two-value field	52
Heading	52
Time	52
Battery display	53
Graphical status icons	53
Function keys	56
Fixed keys	57
Control keys	58
Enter keys	58
Menu tree (Main menu after ON)	59
Instrument operation	61
Main menu	61
Fixed-key occupation in the main menu	62
Fixed-key occupation	63
Measurement & recording	64
Measuring distances and angles together	67
Measuring distances and angles separately	68
Target-point data	70
Remarks	71
Incrementing point numbers	72
Set and define prisms	73
Reduced input of ppm values	75
Comprehensive distance corrections (ppm)	76
Manual distance entry	79
Target eccentricity	80
Individual point number	81
Set station data	82
Select user template and measurement file	82
Station entry/setting	82
1-point orientation	88

Data management	90
Entering coordinates	91
Deleting data	91
View data	92
Edit data	92
Leica prisms and retro tapes	93
Prism for attachable EDM	93
Prism for incorporated EDM	94
The GRZ4 360° reflector	95
Leica retro tapes	96
Summary	97
Long distances	97
Extra	98
On-line mode	99
Format a memory card	100
Remote-control mode	101
Configuration	102
System date and time	104
Define functionality	105
Interface parameters (GSI)	107
Interface parameters (GeoCOM)	108
Instrument identification	109
Auto-start configuration	110
System protection	111
User configurations	113
Functions of the fixed keys	124
Code information	124
Illumination	126
Electronic bubble	128
aF... - Additional functions	129
ON/OFF	141
EDM selection	142
Automatic Target Recognition	143
Functionality	144
Operation	146
Automatic Target Recognition ATR I	
resolution modes	152
Information on the use of Automatic Target	
Recognition ATR I	156
Reduction of the range	157
Disturbance	158

RCS (Remote Controlled Surveying)	161
Introduction	161
Setting up	163
Allocation of keys	166
Working procedure	167
Compass	168
Hz / V	170
Joystick	171
Lock interruption	172
Last point stored	172
Guide Light EGL1	173
ON / OFF	173
Checking and adjusting	175
Electronically	175
Compensator (electronic bubble)	177
V-index error	180
Line of sight	184
Tilting axis	188
Combined error determination	191
ATR1 collimation	191
Mechanically	195
Tripod	195
Bull's eye bubble on instrument	196
Bull's eye bubble on the tribrach	196
Optical plummet	197
Laser plummet	199
Care and transport	201
Battery charging	203
Battery chargers GKL22 and GKL23	203
Battery chargers GKL12 and GKL14	204
Data format	205
Introduction	205
GSI storage format with 8 or 16 characters	205
Block concept	206
Code block	207

Structure of a block	207
Measurement block	207
Terminator of a data block	208
Structure of a word	208
Word index (positions 1 - 2)	209
Information relating to data (positions 3 - 6)	211
Data (positions 7 - 15/23)	213
Separating character (position 16/24)	214
Block number	214
Units of measurement	215
Example of data format	216
Safety directions	219
Intended use of instrument	219
Limits of use	221
Responsibilities	221
Hazards of use	222
Laser classification	228
Integrated distancer (EDM)	228
Automatic target recognition (ATR1)	229
Guide light EGL1	231
Laser plummet (only Txx xxxxL)	233
Electromagnetic acceptability	237
FCC statement (applicable in U.S.)	238
Product labeling	239
Technical specifications	240
Technical specifications of the Automatic Target Recognition ATR1	244
Technical specifications of the EGL1 Guide Light	245
Application programs	246
Atmospheric corrections	247
Index	249

TPS 1000 stands for **T**achymat, **T**heodolite or **T**otal station **P**ositioning **S**ystem and expresses the true integration of computerization with total station technology.

The system offers more functionality and greater flexibility for a wider variety of survey applications and yet improves user comfort and productivity.

The large display is positioned conveniently under the telescope to give the user access to much more information at a glance. The keyboard, with its function keys, is easily understood and permits convenient input. Removable data storage, the large battery capacity and on-board application programs ensure that every available facility is contained in one unit. The TPS1000 is ready for use as soon as it is set up and turned on. No additional cabling to batteries or data recorders is necessary. However, external data loggers, computers or batteries can be connected.

Computer industry standards have been incorporated such as the removeable PCMCIA card for data storage. The data structure is compatible with previous and other current Leica total stations and electronic theodolites. This permits data interchangeability with Leica GPS - Systems. Individual application programs are available or can be written by the user.

Motorized versions of the TPS-System 1000, and versions equipped with the ATR1 automatic target recognition system, ensure higher levels of productivity for repetitive pointing or for stake out applications.

The TC2003/TCA2003 high-performance Total Station differs considerably from other instruments of the TPS1000 family in some features.

Three performance characteristics of the TC2003/TCA2003 have changed

Angle measurement accuracy	0.5" (0.15 mgon)
Distance measurement accuracy	1 mm + 1 ppm
Searching accuracy (TCA version)	
up to 200m	1 mm

(All specifications are standard deviations)

All instruments of the 2003 version are supplied with a quality certificate.

As standard the application software "Monitoring" is implemented in the TCA2003.

The TC2003/TCA2003 instruments are equipped with a special carrying handle. This handle is an integrated part of the instrument and should always be fitted to the instrument during measurements.



Make sure that the carrying handle is carefully fitted to the instrument and that the mounting screws are tighten.

Area of applicability of this User Manual

This manual applies to all TPS1000 instruments and to the TC2003/TCA2003 instruments.

Differences between the various models are clearly set out and assigned.

General text applies to all types.

General illustrations represent the TCA 1800 instrument with EGL1 guide light option and apply to all models.

The present User Manual is valid for the software version 2.2.

Instrument descriptions

T - Version

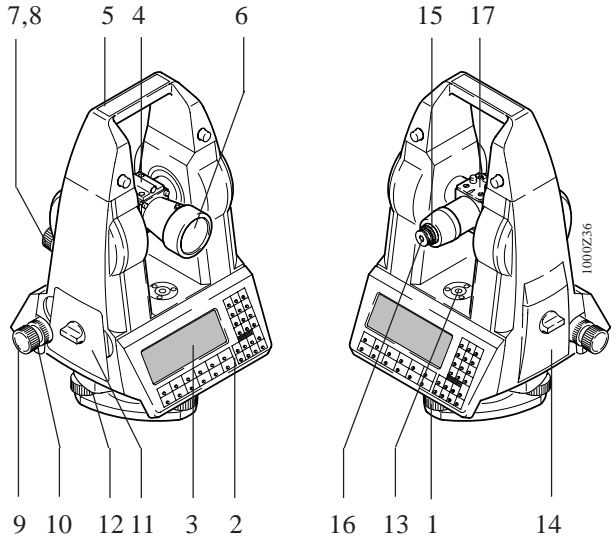

- 1 Footscrew
- 2 Keyboard
- 3 Display
- 4 Optical sight
- 5 Carrying handle
- 6 Telescope
- 7 Vertical drive screw
- 8 Vertical clamp
- 9 Horizontal drive screw
- 10 Horizontal clamp
- 11 Battery housing
- 12 Tribrach securing knob
- 13 Bull's-eye bubble
- 14 Memory card housing
- 15 Focusing ring
- 16 Interchangeable eyepiece
- 17 Adapter for attaching EDM

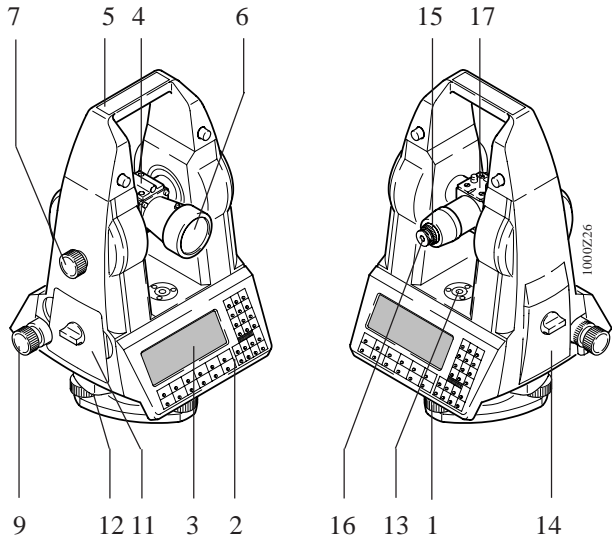

- | | | | |
|---|------------------------|----|---------------------------|
| 1 | Footscrew | 11 | Battery housing |
| 2 | Keyboard | 12 | Tribrach securing knob |
| 3 | Display | 13 | Circular level |
| 4 | Optical sight | 14 | Memory card housing |
| 5 | Carrying handle | 15 | Focusing ring |
| 6 | Telescope | 16 | Interchangeable eyepiece |
| 7 | Vertical drive screw | 17 | Adapter for attaching EDM |
| 9 | Horizontal drive screw | | |

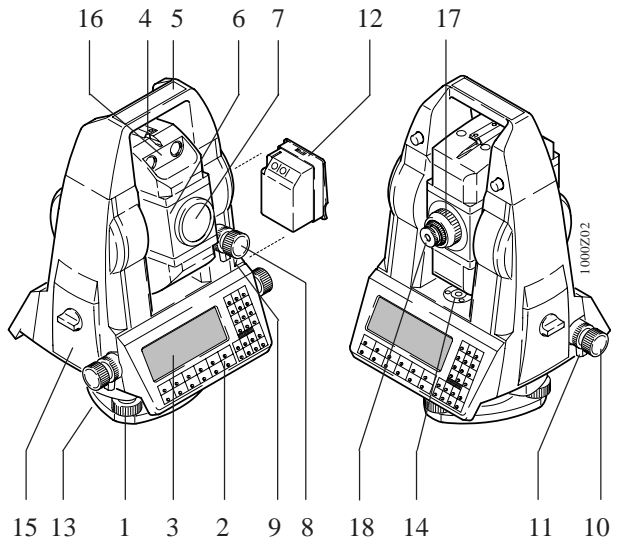

- | | | | |
|---|--|----|-----------------------------|
| 1 | Footscrew | 10 | Horizontal drive screw |
| 2 | Keyboard | 11 | Horizontal clamp |
| 3 | Display | 12 | Battery housing |
| 4 | Optical sight | 13 | Tribrach securing knob |
| 5 | Carrying handle | 14 | Bull's-eye bubble |
| 6 | Telescope with integrated EDM | 15 | Memory card housing |
| 7 | Coaxial optics for angle- and distance measurement | 16 | EGL1 Guide light (optional) |
| 8 | Vertical drive screw | 17 | Focusing ring |
| 9 | Vertical clamp | 18 | Interchangeable eyepiece |

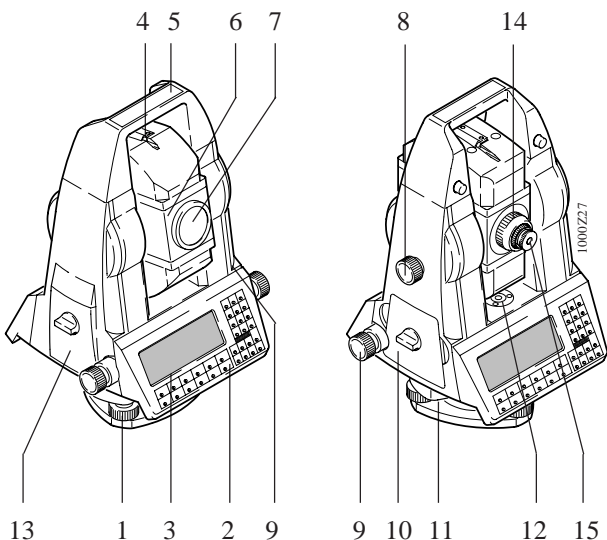

- | | | | |
|---|--|----|--------------------------|
| 1 | Footscrew | 8 | Vertical drive screw |
| 2 | Keyboard | 9 | Horizontal drive screw |
| 3 | Display | 10 | Battery housing |
| 4 | Optical sight | 11 | Tribrach securing knob |
| 5 | Carrying handle | 12 | Bull's-eye bubble |
| 6 | Telescope with integrated EDM | 13 | Memory card housing |
| 7 | Coaxial optics for angle- and distance measurement | 14 | Focusing ring |
| | | 15 | Interchangeable eyepiece |

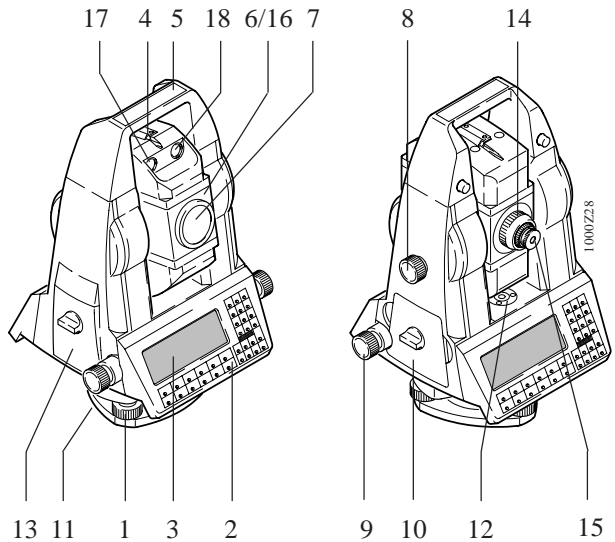

ID

- | | | | |
|---|--|----|--------------------------|
| 1 | Footscrew | 8 | Vertical drive screw |
| 2 | Keyboard | 9 | Horizontal drive screw |
| 3 | Display | 10 | Battery housing |
| 4 | Optical sight | 11 | Tribrach securing knob |
| 5 | Carrying handle | 12 | Bull's-eye bubble |
| 6 | Telescope with integrated EDM | 13 | Memory card housing |
| 7 | Coaxial optics for angle- and distance measurement | 14 | Focusing ring |
| | | 15 | Interchangeable eyepiece |

with EGL1 Guide light (Option):

- 16 EGL1 Guide light
- 17 Flashing left diode (yellow)
- 18 Flashing right diode (red)

Preparing to measure, setting up

Unpacking

Remove instrument from transport case and check for completeness:

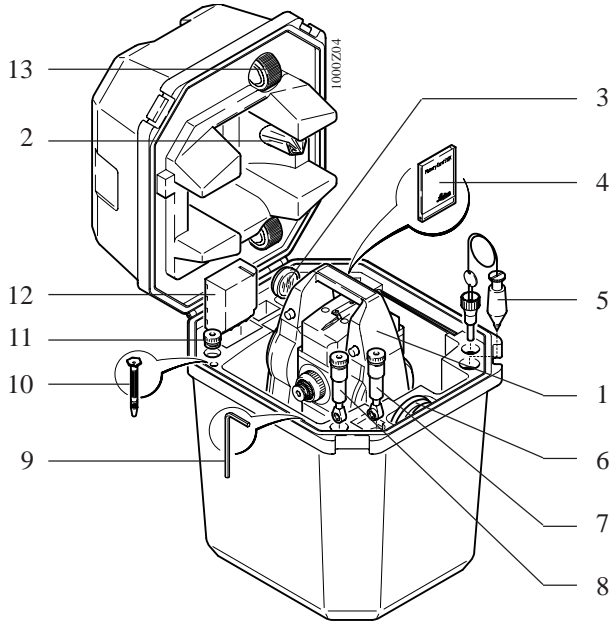

- | | |
|--|--|
| 1 Instrument | 8 Zenith eyepiece (optional) |
| 2 Protective cover | 9 Allen key |
| 3 Focusing sleeve (optional) | 10 Screwdriver, set pin |
| 4 Memory card (optional) | 11 Interchangeable eyepiece (optional) |
| 5 Plummet (optional) | 12 Spare battery (optional) |
| 6 Cable (optional) | 13 Shoulder straps |
| 7 Eyepiece for steep angles (optional) | |

Charging battery

Charge batteries using GKL12, GKL14, GKL22 or GKL23. For more information about charging batteries refer to chapter "Battery charging".

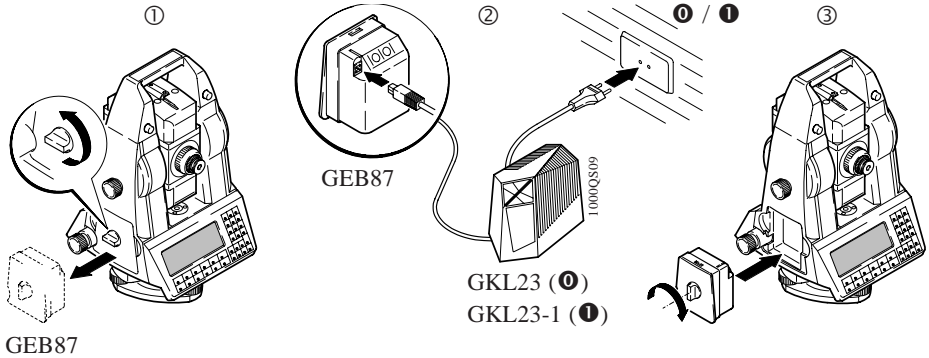

Charging time: 1.5 hours

External batteries:

GEB70: 1.5 hours

GEB71: 5.0 hours

0 230V ±10%

1 115V +10/-20%



WARNING:

The battery chargers are intended for indoor use only. Use a battery charger in a dry room only, never outdoors.

Preparing to measure T- and TM - Versions

Before using the theodolite version for the first time, certain precautions need to be taken:

The black plastic protective cover on the telescope connector should be removed with a knife blade or screwdriver before fitting the EDM (=Electronic Distance Measuring instrument).

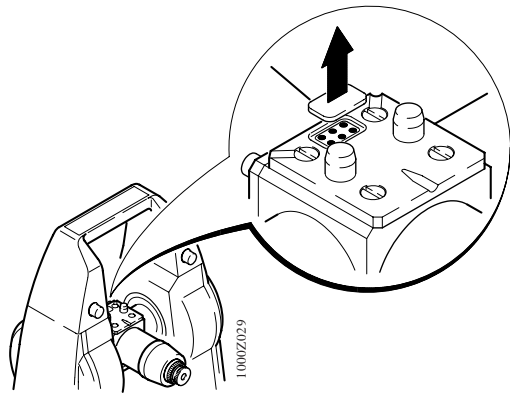

Remove the protective plastic cover

Make sure that the ppm- and mm-values stored in the EDM are reset to "0.00".

Line up the axis of the EDM to that of the theodolite as described in the user manual for the EDM, but first enter the model of EDM in the TPS1000. For more information, please refer to the chapter "First steps".



Measuring with connected EDM is to be performed when the EDM is above the telescope, otherwise distances may be reduced wrongly.

When the theodolite is used in conjunction with the EMD models DI1001, DI1600, or DI2002, we recommend using the GPH1A single-prism holder for measuring over short distances.

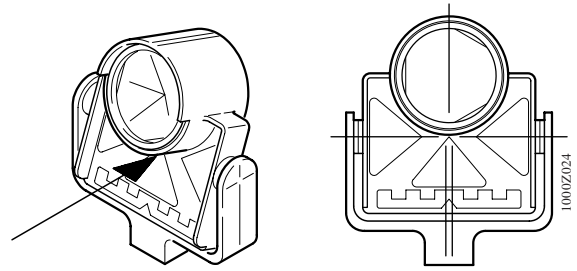

GPH1A single-prism holder

The height difference between the telescope's optical axis and the infra-red beam is corrected by the corresponding difference at the target, therefore **aim the crosshairs at the yellow target mark**.

***Preparing to measure
with TC, TCM and
TCA - versions***

For instruments with built-in EDM, no preliminary adjustments to the EDM are required before use.

We recommend using the GPH1 single-prism holder. The intersection of the vertices of the prism lies exactly at the intersection of the rotation axes of the reflector and can therefore be used directly as the target. For perfect targeting of the GPH1 over longer distances the additional GZT4 target is recommended. The telescope of the EDM is adjusted during manufacture so that the measuring beam lies exactly on the optical axis.

PM

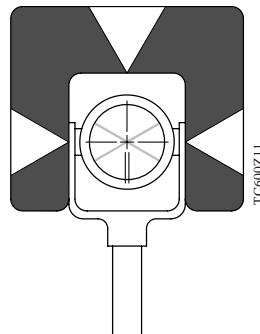

GPH1 prism holder with GZT4 target plate

Aim the crosshairs at the centre of the reflector. TCA models can target the centre of the prism automatically.

Setting up the instrument

Tribrach with optical plummet

GDF 22 tribrach
GST20 tripod

1. Set up the GST20, centring it as well as possible.

PM

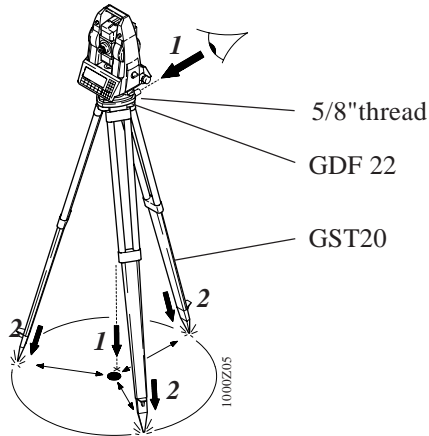
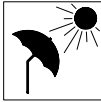

2. Using the footscrews of the GDF22, centre the plummet to the ground point.

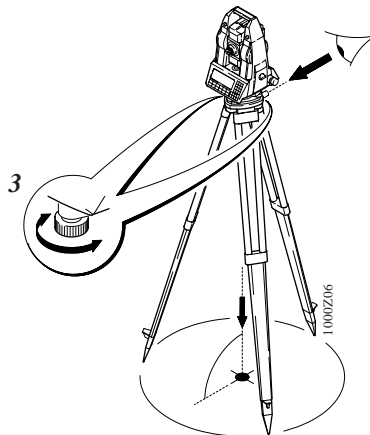

3. Move the legs of the tripod to centre the bull's-eye bubble.

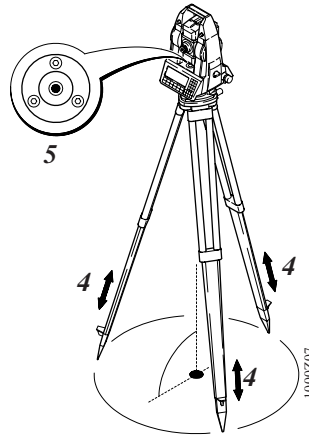

4. Level-up precisely, using the electronic bubble (see the chapter "Levelling-up with the electronic bubble").
5. Centre exactly by shifting the GDF on the tripod plate.

Repeat steps 4 and 5 until the required accuracy is reached.



The laser plummet cannot be used in conjunction with a tribrach which already has an optical plummet.

Tribrach without optical plummet

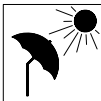

GDF 21 tribrach
GST20 tripod

PM

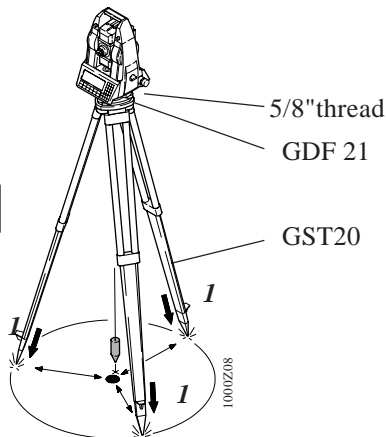

1. Set up the GST20, centring it as well as possible.

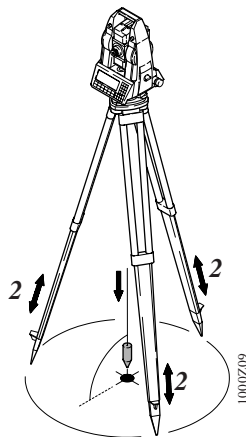

2. Centre by moving the tripod legs.

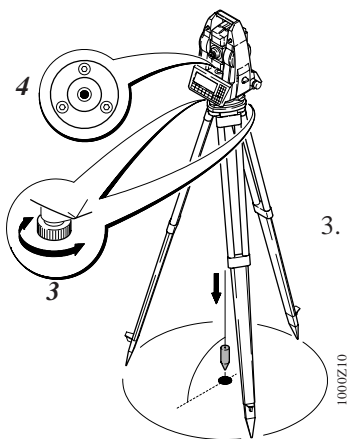

3. Move the footscrews of the GDF21 to centre the bull's-eye bubble.

4. Level-up precisely, using the electronic bubble (*see the chapter "Levelling-up with the electronic bubble"*).

5. Centre exactly by shifting the GDF on the tripod plate.

Repeat steps 4 and 5 until the required accuracy is attained.

Laser plummet in instrument

The laser plummet is built into the standing axis of the "L" versions of the TPS1000 instruments. A red dot projected on the ground makes it much easier to centre the instruments. The laser plummet is activated with



(see chapter "Illumination").

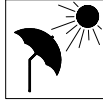

GDF 21 tribrach
GST20 tripod

PM

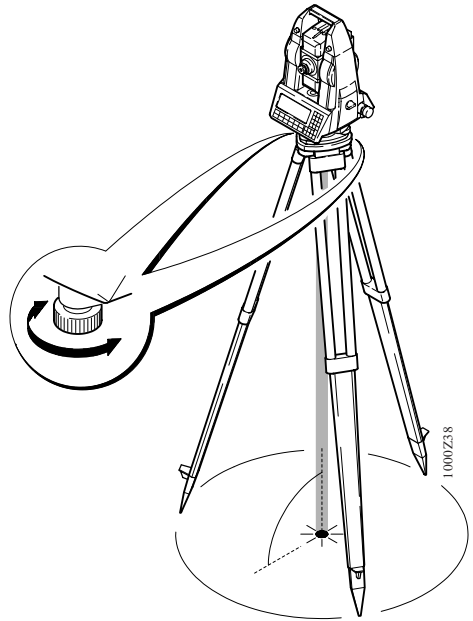
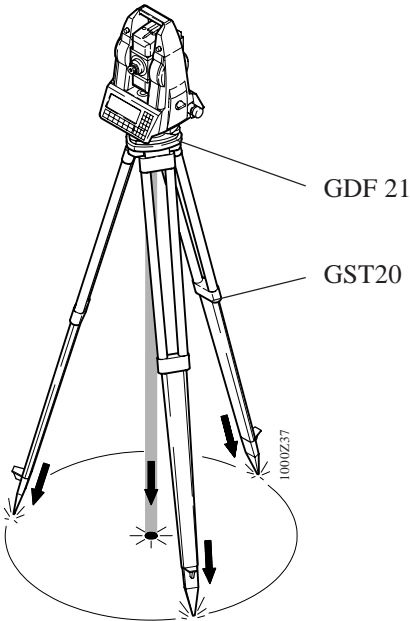

1. Set up the GST20, centring it as well as possible.

2. Move the footscrews of the GDF21 to centre the plummet over the ground point.

3. Move the tripod legs to centre the bull's-eye bubble.

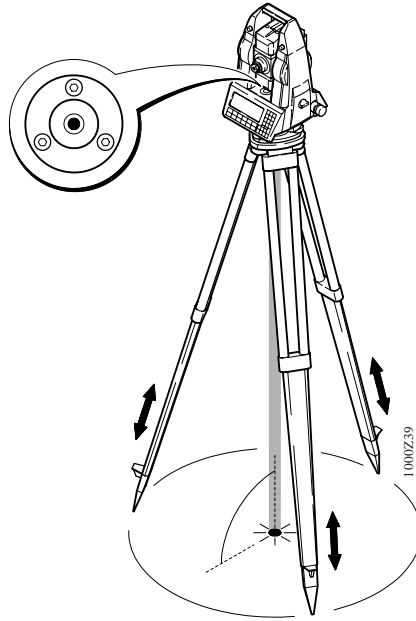

PM

4. Level-up precisely, using the electronic bubble (*see the chapter "Levelling-up with the electronic bubble"*).

5. Centre exactly by shifting the GDF on the tripod plate.

Repeat steps 4 and 5 until the required accuracy is attained.

First steps

Switching on the instrument

Set up in accordance with the chapter "Setting up the instrument".



Switch on.

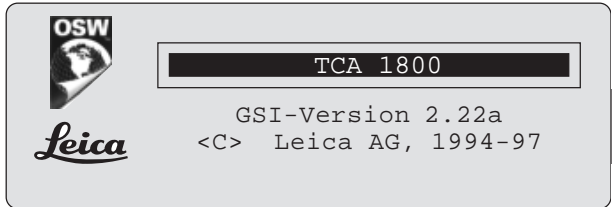

After switching on, the instrument type and the software version are briefly displayed.

The display automatically jumps to the main menu. Depending on the configuration, it is also possible to start an application automatically (see chapter "Configuration").

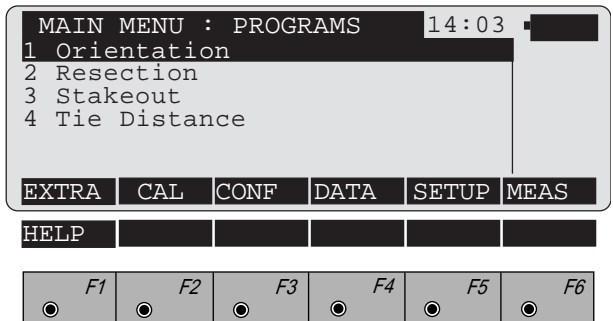



Show on-line HELP information for the main menu.
On-line HELP information is available for all dialogs.

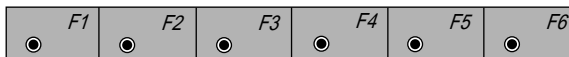
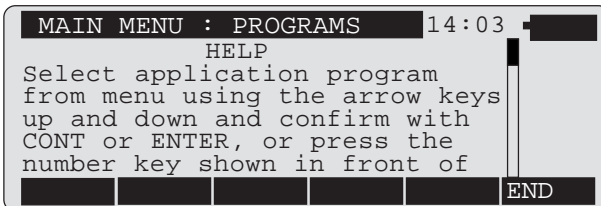

FS



Leave the HELP screen and return to the main menu.

Levelling-up with the electronic bubble



Graphical and numerical display of the longitudinal and transverse tilt of the instrument's vertical axis.

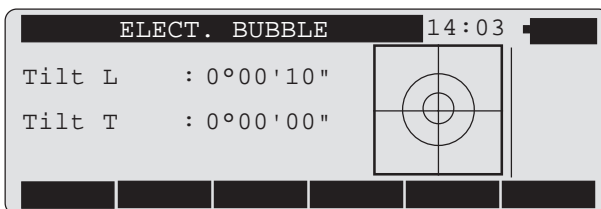

HELP



Using the footscrews, the instrument can be levelled-up without having to turn it through 90° (100 gon) or 180° (200 gon).

In the display which is closest to the bull's-eye bubble, the movement of the small circle runs parallel to the movement of the bubble in the alidade. The other display shows the movement in the opposite direction.

Installing a distancer (EDM)

Only for T- and TM-Versions with attached EDM:
The type of EDM used must be entered in the system.



Choose the user configuration.

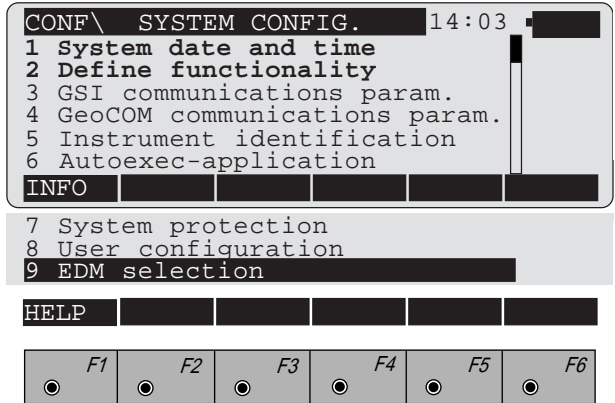

FS



Move the inverse bar to "EDM selection".



Confirm input

or



choose directly.



The above dialog is dependent on the definition of the functionality.

The following options are available in the reduced menu structure:

- Functions where the cursor bar is positioned
- Functions in **heavy** type (this does not apply to the instrument itself).

All of the displays which are unaffected by the functionality are displayed without heavy type.

The appropriate distancer can be selected from the following dialog.

CONF\ EDM SELECTION		14:03
Select EDM		
EDM type :	DI1001	▼
EDM offset :	40.9mm	
Wavelength :	850nm	
		LIST



Shift

HELP

F1 F2 F3 F4 F5 F6

F6

Choose from the EDM list.

Using the  and -keys, choose the relevant EDM:
(DI3002 = DIOR3002 and DI3002S = DIOR 3002S)

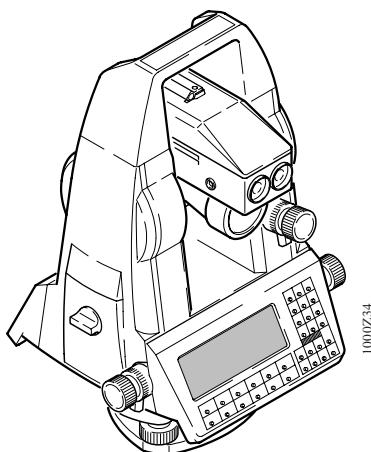

T-Version with distancer DI1600



Confirm the choice.

The "EDM offset" (distance between telescope axis and EDM axis) and the wavelength are automatically set.

The correction of the EDM offset can be turned on and off in the option target point (see chapter "Target-point data").

CONF

Leaves the "EDM SELECTION" menu.

Measuring distances and angles

- F6** Select "MEASURE MODE (GSI)" from the main menu. In the measuring dialog, distances can be measured, angles displayed, point numbers entered and data recorded.

MEAS\ MEASURE MODE (GSI) 14:03				
Point no. :		1		
Remark 1 :		-----		
Refl.Height :		0.000 m		
H _z :		295°22'40"		
V :		91°20'30"		
Horiz. Dist. :		37.127 m		
ALL	DIST	REC	TARGT	Hz0 αNUM
Height diff: -0.870 m				
Easting : 554.386 m				
Northing : -873.330 m				
Elevation : 13.227 m				

Shift









HELP		LAST	I<>II		PROG
F1	F2	F3	F4	F5	F6

- F1** Distance is measured and current measured values are stored.
- F2** Distance is measured and measured values are displayed.
- F3** Current measured values (shown on the display) are stored. If the distance measurement was activated with **F2**, the distance will also be stored.

The measurement dialog is described in detail in section "Measurement & Recording".

Summary of the first steps

FS

- Step 1:** Set up the instrument and level-up using the bull's-eye bubble.
-  **Step 2:** Switch on (the instrument display shows the main menu).
-   **Step 3:** Show HELP information for the main menu.
-  **Step 4:** Leave the HELP screen and return to the main menu.
-  **Step 5:** Adjusting the electronic bubble.
-  **Step 6:** For T- and TM-version only:
In the system, select the EDM used with the theodolite.
-  **Step 7:** Select measure mode directly from main menu.
-  **Step 8:** Target the prism and start a distance measurement. Once measured, the horizontal distance is displayed on the bottom line.
-  Measuring with connected EDM (T- and TM-versions) is to be performed only when the EDM is above the telescope, otherwise distances may be reduced wrongly.

System concept

The TPS1000 series includes many different instruments: electronic theodolites and total stations of various accuracy classes, with or without motorization, and total stations with automatic targeting.

All of these models use the same software architecture and the same concept for data storage and data flow.

Software architecture

The software of the TPS1000 can be divided into two groups:

- The **system software**, which covers the basic functions
- The **applications software**, which supports survey-specific applications and procedures.

The system software forms a coherent unit, whereas the applications software can be compiled in accordance with the individual requirements of the user.

Using the "**workbench**" provided, both the system software and the applications software can be loaded across the serial interface by the user, who is in a position to install improved software versions.

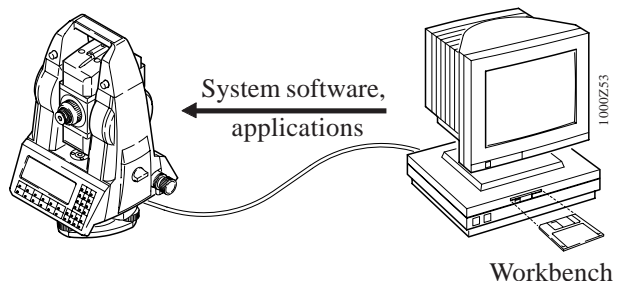

The software permits up to three languages to remain stored simultaneously and one of them to be selected. The range of language versions available is constantly being expanded. If you need a particular language version, please ask your agency about its availability.

Memory concept and data flow

In general, measurement data is stored on an SRAM memory card (from here on referred to as "MC") which meets PCMCIA standards. Cards with a capacity ranging from 512 Kbytes to 4 Mbytes can be used. The data are stored in MS-DOS format. Data is exchanged with the PC either through a PCMCIA drive on the PC or across the serial interface. The "Workbench" disk supplied with the product contains software appropriate for data transfer across the serial interface.

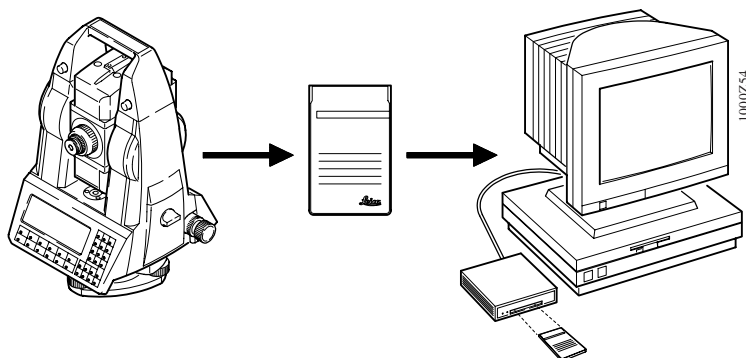

The structure of the directory on the MC is fixed. It includes two subdirectories for the TPS1000:

\GSI
\LOG

The directory \GSI includes files in the GSI data format (*see chapter "Data format"*).

A distinction is made between:

- Input data, generally fixed-point coordinates
- Output data, generally measurements, coordinates, or derived values relating to "new points".

It is advisable to store the input and output data in two separate files, although it is possible to store them together in a single file.

A maximum of 24 files can be managed. Twelve of them already have permanent names (FILE01.GSI to FILE12.GSI) and are used primarily to store measurement data (measurement files). The remaining twelve files can be given any name, but this must always terminate with GSI (e.g. PROJ2563.GSI). It is useful to store the fixed-point coordinates in these files (data files).

SC

In the directory \LOG, additional data from most of the loadable applications can be stored in a protocol file.

Instead of using the MC, the data can be output in GSI format at the serial data interface.



When data storage is performed across the serial interface, no data from the applications is output into the protocol file. Fixed-point coordinates can be read only from the MC.

Operating modes

Normal operation involves an observer who keys-in information and who moves the telescope and points the instrument manually. The results of the measurement are displayed and stored.

The instrument can also be operated partially by sending user-defined commands across the serial interface (reduced RS232 interface). If the instrument has automatic target recognition, it can be operated fully in this manner.

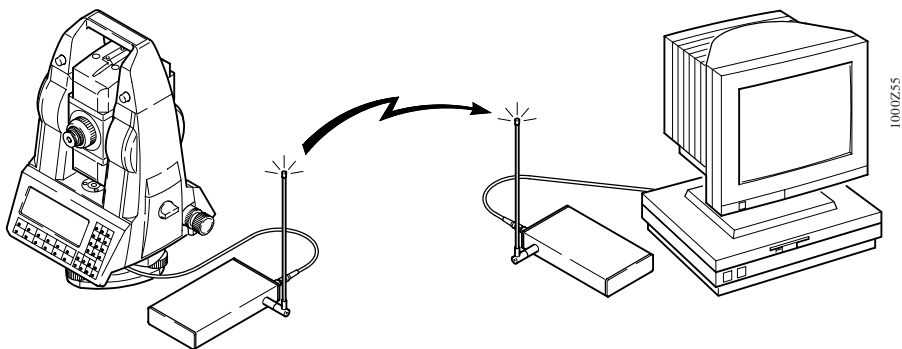

Two sets of commands are available for controlling the instrument:

- The **GSI command** set has a simple structure and so can be easily learned. It is particularly suitable for use in external data-recording instruments. It contains control commands which are adequate for simple applications in conjunction with motorized instruments and with instruments having automatic target recognition (ATR). For more information, please refer to *"WILD Instruments On-Line"* (document no. G-366-0en), a copy of which is available (in English only) from your local Leica agency.
- The **GeoCOM command** set governs complex operations in the TPS1000 instruments and is to be preferred for the professional development of control programs. For more information, please refer to *"GeoCOM Reference Manual"* (document no. G-560-0en), a copy of which is available (in English only) from your local Leica agency.

GeoBasic

The GeoBasic development environment permits the professional development of additional applications for the TPS1000. For more information, please refer to *"GeoBasic Compiler and Keyboard Simulator"*, a copy of which is available (in English only) from your local Leica agency.

Operating concept

The TPS1000 system is organized into various functions, which are started via the **function** keys in the main menu or via the hard keys.

The use of **loadable applications** can meet specific user requirements, which are then called up from the list of applications in the main menu.

Each application or function is divided into **dialogs** which include interrelated information.

Display / keyboard

The display and the keyboard are divided into specific areas, making the layout clear and the operational procedure easy to learn.

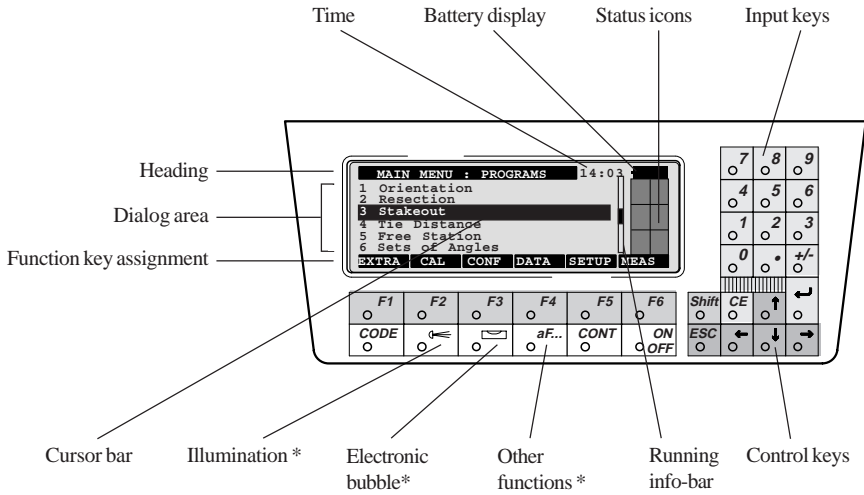

* => always accessible !

The four colour groupings for the keys are:

White: Fixed keys

Orange: Function keys

Green: Control keys

Yellow: Numeric and entry keys





The graphical display is arranged with 8 lines of 35 characters. Graphics can be displayed with a resolution of 64 x 210 pixels across the full display area.

Types of dialog

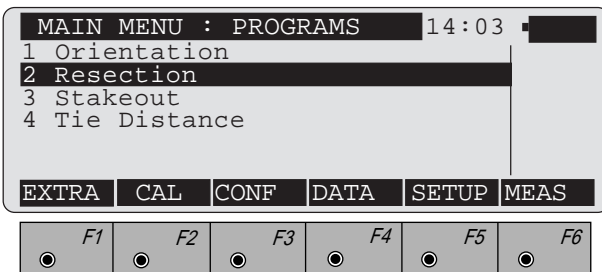
To give an overall view, several types of dialog are used. The input procedure is the same within all types of dialog, promoting ease in use. The following examples illustrate the types of dialog used in the TPS1000.

Program-selection dialog



To start the program "Resection", the cursor bar is moved by means of the arrowed keys ,  to the appropriate field and is started with  or 





the function is called directly.

MEAS \ MEASURE MODE (GSI) 14:03					
Point no. :					1
Remark 1 :					
Refl.Height :		0.000	m		
Hz :		295°22'40"			
V :		91°20'30"			
Horiz.Dist.:			m		
ALL	DIST	REC	TARGT	HZ0	αNUM
<input type="radio"/>	<input type="radio"/>	<input type="radio"/>	<input type="radio"/>	<input type="radio"/>	<input type="radio"/>

The dialog mostly consists of several display fields. To enter a value, the cursor bar must be moved to the appropriate field (e.g. "Point no.").

OC

If the entry is concluded with  the cursor bar can then be moved to another input field (e.g. Refl. Height) for entering this value.

If the entry field is closed with , this concludes the input and generally also quits the dialog. All values entered are accepted.

The cursor bar cannot be moved within a field used exclusively for output. The values in that field (e.g. measurements such as "Hz" and "V") cannot be changed.



This rejects the entries made in a dialog field and returns it to its condition before it was called. In general there is a simultaneous jump back to the previous dialog.

Fields in the input dialog

The input of all sorts of information is supported by several types of input fields. The input procedure is the same within all types of dialog, promoting ease in use. If the type of input field is not clear, it can be identified from the assignation of the key . The examples below illustrate the types of field used in the TPS1000.

The -key is assigned with "αNUM".

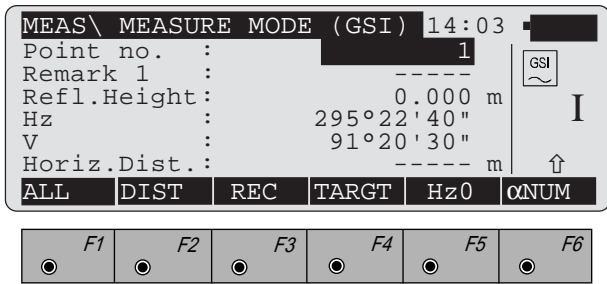

All entries not subject to restrictions belong to this type, e.g. point numbers, coding. Any alphanumeric characters can be entered.

Numeric values are entered by means of the input keys, the rest of the characters by means of the function key . The maximum number of characters which can be entered depends on the input field.

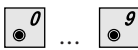

If the entry is commenced with a numeric key, the previous value is deleted.



The preset value is not deleted and the entry mark is located at the left-hand end of the field.



The preset value is not deleted and the entry mark is located at the right-hand end of the field.

The function keys are assigned with alphabetic characters in all cases.

With an additional function key an alphabetic character is assigned to each individual function key and can be selected directly.

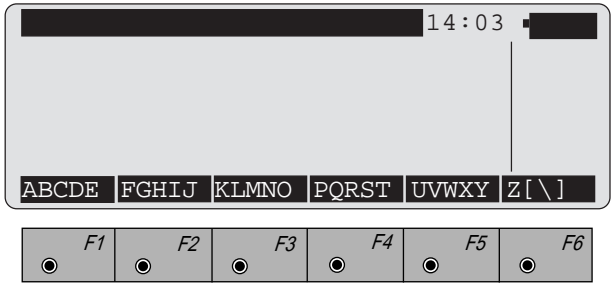

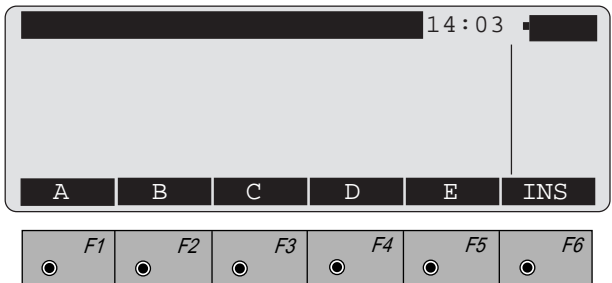

The following display appears:

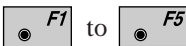

OC



are now assigned individual characters which can be chosen.

Additionally, the  and  control keys can be used to select the complete ASCII character set a block at a time.



Possible blocks of characters:





- **Insert mode**

If the entry mark is at the right-hand end of the input field, the new character will be appended to the existing one.

If the entry mark is at another position in the input field, the character will be written over.

"INS" is assigned to the -key if a function key was previously used to select an alphanumeric block. The  and  control keys can be used to move the entry mark over a digit or character before which a character can now be inserted. The character is always inserted before the cursor.



In a numeric field the insert mode is also called with . The insert mode remains active until it is deactivated with  or until quitting the field.

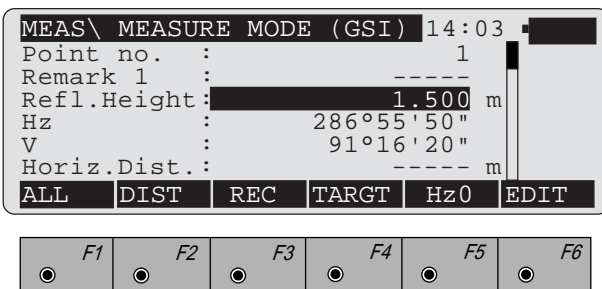

The -key is assigned with "EDIT".





All entries requiring **numeric** input (e.g. point coordinates) are of this type. The permitted number of digits, the decimal place etc. are all assigned automatically, and the units used are indicated.

OC

 ...  If the entry is commenced with a numeric key, the previous value is erased.

  The previous value is not erased and the entry mark is located at the left-hand end of the field.

  /  The previous value is not erased and the entry mark is located at the right-hand end of the field.

Some numeric fields permit input only at a preset interval. Deviations from this interval provoke an acoustic signal and the value is set to the minimum or maximum value.

List field

"LIST" is assigned to the  -key when the symbol ▼ is shown at the end of a line. Open a list field to select parameters from it.

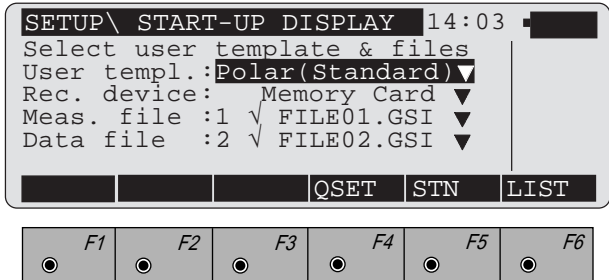

All entries which permit only a certain input belong to this type, e.g. the name of a file.

OC



Open the list field.

The following display shows a typical example for an opened list field:

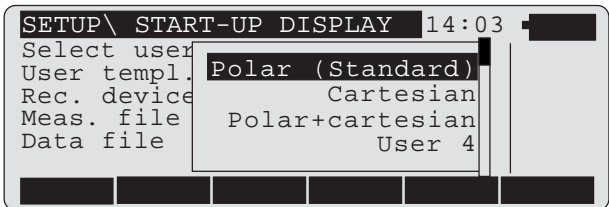

Selects.



Confirm selection.

In numeric list fields, and in some alphanumeric ones, an entry can be called directly by keying-in the value instead of using  .

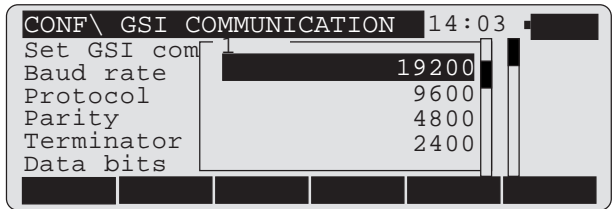

Example:

Keying-in "1" marks the baud rate (19200)

The entry is concluded with  .

OC

In alphanumeric list fields the entry can be chosen quickly using the accompanying number tag.

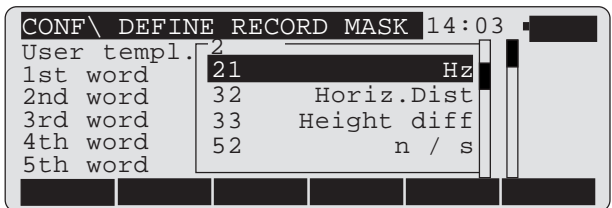

Example:

Keying-in "2" marks "Hz".

The entry is concluded with  .

Two-value field

aF... \BEEP / HZ-SECTOR		14:03
Set Beep and Hz-sector		
Keyst. Beep :	loud	▼
Sector Beep :	OFF	
Angle :	90°00'00"	
		→ON

F1	F2	F3	F4	F5	F6
●	●	●	●	●	●

All entries permitting only two values belong to this category, e.g. sector beep (ON/OFF).

The value which was set always appears in the input field; the alternative value is called with .

Additional pairs are:

OLD / NEW
YES / NO
ON / OFF
etc.

OC

Heading

MEAS \ MEASURE MODE (GSI)		14:03
Point no. :		1
Remark 1 :		
Refl. Height :	0.000	m
Hz :	295°22'40"	
V :	91°20'30"	
Horiz. Dist. :		m
ALL	DIST	REC
TARGET	HZ0	αNUM

F1	F2	F3	F4	F5	F6
●	●	●	●	●	●

The title line contains the designation of the particular dialog. At the start of the title line the active function or the application is displayed (maximum 5 characters).

Time





14:03

The time as used by the system.

The correct time is maintained, even when the main battery is removed, by an internal back-up battery.

Battery display

When the battery is fully charged the battery display is seen also to be full. As the battery is discharged, the display records this in 4 increments.

-  Battery fully charged
-  Battery almost fully charged
-  Battery still capable of being used
-  Battery reserve power. Only 25 more distance measurements may be possible. The user is warned accordingly of an empty battery.

Graphical status icons

Operating mode

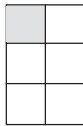

The TPS1000 can be controlled **only** across the RS232 interface in the GEOS command format. The keyboard cannot be used for this purpose. *Refer to chapter "On-line mode".*



The instrument is operated from the keyboard and/or across the RS232 interface (GSI- or GeoCOM commands).



Remote control is ON. The instrument is operated from the keyboard and/or from the RCS1000.



The instrument can be operated only from the keyboard.

Data storage device field

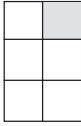

No memory card has been inserted.



Memory card has been inserted.

Compensator field

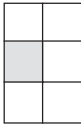

The compensator cannot be read. Instrument is either at too great a gradient, unstable, or has been turned quickly, etc.



Compensator or Hz-correction has been disabled.



The compensator functions normally and the Hz directions are corrected.

OC

Telescope face display field

Displayed only in measuring mode.

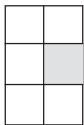

I

Face 1

II

Face 2

Automatic target recognition

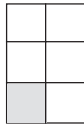

Automatic target recognition is activated.



Automatic target tracking (LOCK) is activated, but no prism has been targeted or lock to prism has been lost.



LOCK is activated, target is tracked.



Lock to prism has been lost. Search is in progress.



ATR or LOCK is not active.

OC

Key-mode field

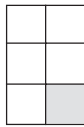

 has been pressed.



At least one function key in the second level has been assigned (in addition to "HELP").



Further digits need to be keyed in.
Displayed when a menu list has more than 10 entries.



Insert-mode in entry fields activated.

Instrument busy



Instrument busy.
This icon is displayed in the middle of the main display area.

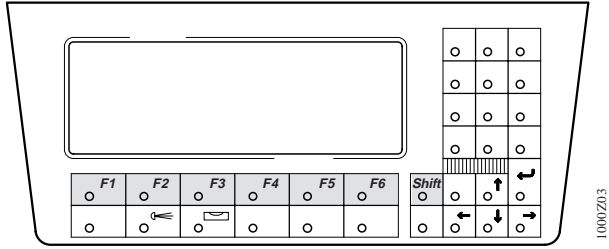

The assignment of the orange keys varies with circumstances. This assignment permits access to functions which are dependent on the particular dialog. To assist user familiarity, the command logic is organized so that the same command normally appears at the same function key.

Detailed information regarding the functions assigned to these keys can be found in the *chapter "Instrument operation"*.

OC

There are two levels for the function keys:

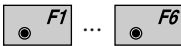

1st level

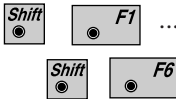

2nd level

Special function key assignments



This is the "HELP" key for every dialog. Here the functionality of the current dialog is briefly described.



Aborts a function or application and returns to the main menu. All entries in the **last** dialog of the function or application are rejected.

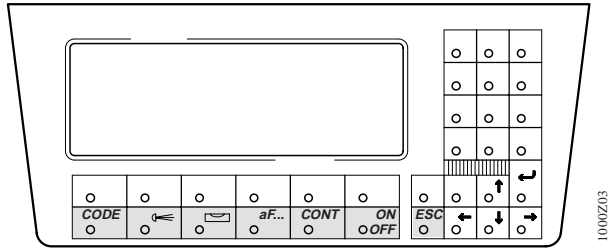

Fixed keys (white)

The functions associated with these keys are available at all times. These keys bypass the current operation sequence to access a system function, returning to exactly the same display afterwards.



Calls code input. *See chapter "Code information".*



Switches illumination ON/OFF. *See chapter "Instrument operation".*



Levels-up the instrument. *See chapter "Instrument operation".*



Various functions. *See chapter "Instrument operation".*



Turns the instrument ON/OFF.



Confirms the values in the dialog, continues to the next display.



Returns one step back to the previous dialog. No entered values or parameters are retained.

Control keys

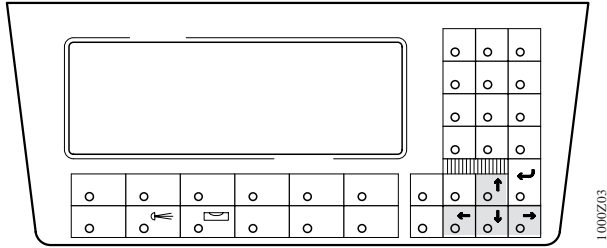

Sets the focus and scrolls through the dialog.



Positions the cursor in order to edit numbers and letters, to insert or delete, and for positioning within a row.

OC

Enter keys

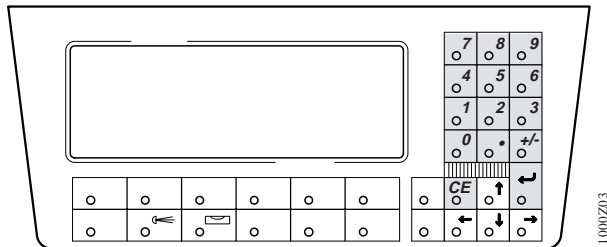

...



Input in numerical fields, or selecting and starting of functions with a related number.



Decimal point and sign.



Confirms the input within a line or the choice from a list.



Deletes the last digit or letter entered.

Menu tree (Main menu after ON)

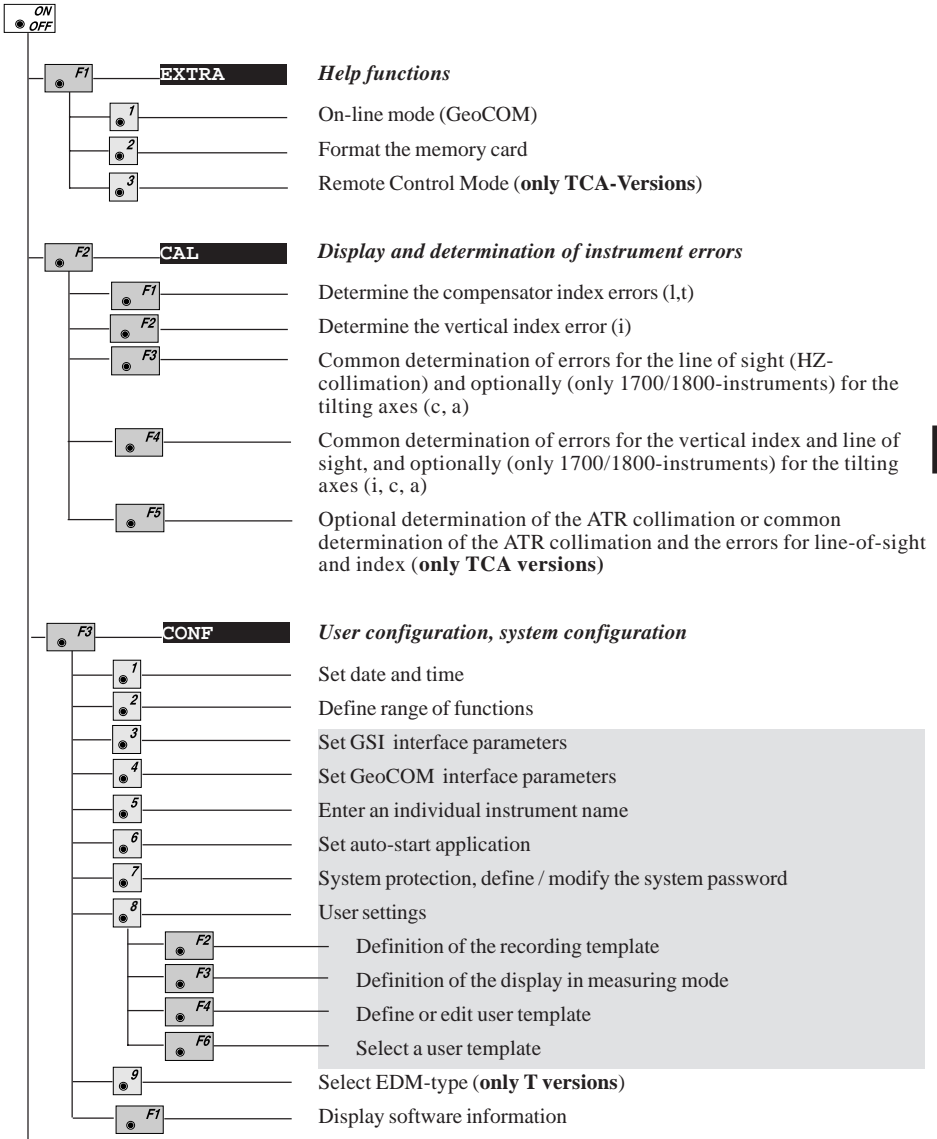

OC

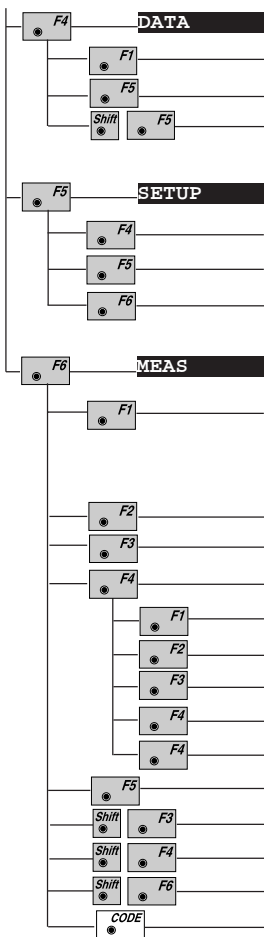

Select the data file and data display

- Manual input of data
- Data search and display
- Erase file

Set station data

- One-point orientation
- Set station data
- Select user settings and files

Measuring mode (measured data display)

- Measure distance and record data into the data file
Display EDM measuring program, EDM type, reflector type, EDM offset correction (only for T versions), prism constant, total ppm correction
- Measure distance without recording
- Data recording into the data file
- Input target data
 - Select and define reflector type
 - Set atmospheric and geometric ppm correction
 - Manual input of a horizontal distance
 - Input of target eccentricity
 - Select individual or running point number
- Hz-circle orientation
- Display last recorded point number
- Positioning in the other face
- Calls list of on-board application programs
- Select existing code function, enter a code block

Coloured field not accessible when in reduced functionality mode

Instrument operation

Main menu

After the instrument has been switched on, the instrument model and software version are briefly displayed. The instrument carries out a system test and then engages the main menu.

The special significance of the main menu is that all fixed system functions and all loadable applications can be started from it, with the exception of the CODE function, which can be called from any dialog which permits data to be stored.

The following overview indicates the assignment of the various functions to the function keys of the main menu and to the fixed keys.

Fixed-key occupation in the main menu

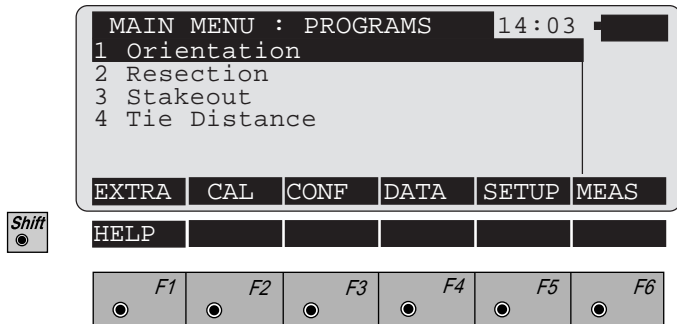

External control by GeoCOM commands; remote control with RCS1000; formatting memory card. *See chapter "Extra".*



Determines axial error and inspects electronic bubble. *See chapter "Checking and adjusting".*



Settings for accommodating to user requirements, e.g. units, interface parameters. *See chapter "Configuration".*



Data- and file management. *See chapter "Data management".*



Input of station data and orientation, selection of user template and measurement file. *See chapter "Set station data".*



Measurement and recording. *See chapter "Measurement and recording".*



A code block with additional information is defined and recorded. In general, the key is activated when measurements or coordinates can be recorded for a point. For details, *see chapter "Code information"*.



Various illuminators can be switched on, and the brightness adjusted.

Depending on the outfit, they are:

- Display contrast
- Display illumination
- Crosshair illumination
- EGL1 guide light
- Laser eyepiece
- Laser pointer for DIOR and DISTO
- Laser plummet

For details, *see chapter "Illumination"*.



Various often-used basic functions which must be adjusted quickly:

- Select user setting, file
- EDM settings
- Compensator settings
- EDM test
- Beep settings
- V-angle settings
- Automatic switchoff criteria
- Settings for automatic target recognition ATR1
- Accessories for telescope

For details, *see chapter "aF.. -Additional functions"*.



The instrument is switched on, switched off, or switched to Sleep mode. For details, *see chapter "ON/OFF"*.

The measurement dialog is of fundamental importance in the TPS-System 1000. Using the appropriate function keys, all of the information relevant to a measurement can be entered. The comprehensive functionality also covers requirements dictated by unusual circumstances. The comprehensive flexibility of the measurement dialog is also available for all loadable applications but occasionally requires slight modification.

The following basic functions are available:

- Simultaneous measurement of distance and angle, using "**ALL**" for recording
- Separate distance measurement using "**DIST**" and
- Storage of the measurement "**REC**".

The horizontal circle can be oriented (Hz0) and application programs started.

Input of various target point data under "**TARGET**". These are:

- Entering target point numbers
- Target-point eccentricity
- Input of remarks 1 - 9
- Choosing various prisms and retro tape targets
- Defining various prism constants
- Entering values used to calculate the atmospheric and geometrical distance corrections
- Entering the refraction coefficient
- Recalling the last point number to be recorded
- Changing the telescope face
- Entering manually-determined horizontal distances
- Incrementing the point number
- Switching from current- to other point numbers.

MEAS \ MEASURE MODE (GSI) 14:03	
Point no. :	1
Remark 1 :	
Refl.Height :	0.000 m
H _z :	295°22'40"
V :	91°20'30"
Horiz.Dist. :	----- m ↑
ALL	DIST
REC	TARGET
Hz0	αNUM
Height diff :	----- m
Easting :	----- m
Northing :	----- m
Elevation :	----- m



HELP		LAST	I<>II	PROG
-------------	--	-------------	--------------------	-------------

F1	F2	F3	F4	F5	F6
-----------	-----------	-----------	-----------	-----------	-----------

The data shown above represent the standard display template.



Distance measurement and measurement-block recording. The recorded measurement block corresponds to the active recording template.



Measure a distance and display it.



Measurement block recording. The recorded measurement-block corresponds to the active recording template. The last measured distance is also recorded.



Call-up target point data (*refer to chapter "Target point data"*)



Sets the horizontal circle to 0° 00' 00" (0.0000 gon) or enter value (meaningful only at face I).



Sets the current point number to be the same as the last one recorded.



Change telescope face. ΔHz and ΔV are displayed. The instrument should be turned until the differential values are both "0.000", and then the same target point appears in the telescope. This procedure is useful in conditions of poor visibility.

Motorized theodolites turn automatically to the other telescope face (TM/TCM- and TCA versions).



Calls the application programs dialog. From here, the application programs can be started.

Explanation of the elements of measurement

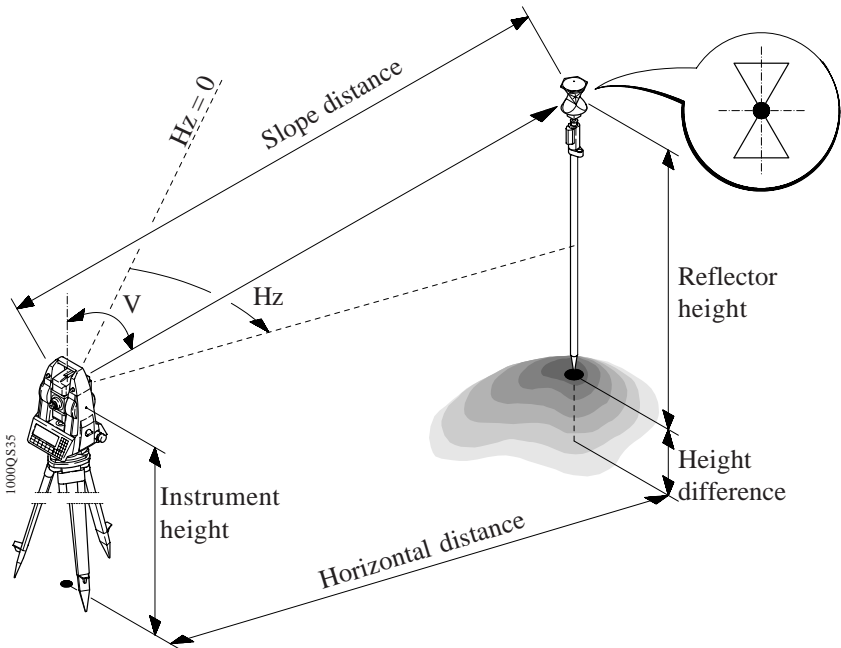

Hz = Horizontal angle

V = Vertical angle

Measuring distances and angles together



Simultaneous measurement and recording.

MEAS\ MEASURE MODE (GSI) 14:03				
Point no. :		100		
Remark 1 :		new		
Refl.Height :		1.500 m		
Hz :		214°52'45"		
V :		85°25'17"		
Horiz.Dist. :		100.251 m		↑
ALL	DIST	REC	TARGET	Hz0 αNUM
Height diff :		23.650 m		
Easting :		76.943 m		
Northing :		1902.437 m		
Elevation :		523.650 m		



HELP	LAST	I<>II	PROG
F1	F2	F3	F4
F5	F6		

IO

Hz-angle measurement is carried out after the distance has been measured. Immediately afterwards all data is stored.



Therefore the instrument may only be moved after data storage is complete.

The data is automatically recorded after the distance has been measured. The distance, and all data which depend on it, are then displayed with the tag "-----", which indicates that the data storage is complete.

Measuring distances and angles separately



Perform a distance measurement.



Record the resulting data.

MEAS \ MEASURE MODE (GSI) 14:03					
Point no. :	100				
Remark 1 :	-----				
Refl.Height :	1.500 m				
Hz :	214°52'45"				
V :	85°25'17"				
Horiz. Dist. :	100.251 m				
ALL DIST REC TARGET Hz0 ONUM					
Height diff :	23.650 m				
Easting :	76.943 m				
Northing :	1902.437 m				
Elevation :	523.650 m				



HELP		LAST	I<>II		PROG
------	--	------	-------	--	------

F1	F2	F3	F4	F5	F6
----	----	----	----	----	----

10

This procedure offers the option of realigning the telescope on another point after measuring the distance and before measuring the angle. In this way two points can be used for measurements of angle and distance.

It is therefore possible to record inaccessible points, e.g. house corners, fences surrounded by hedges.

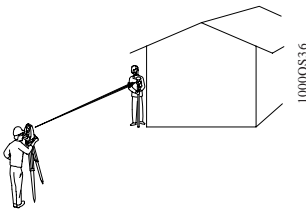

Measuring DISTANCE

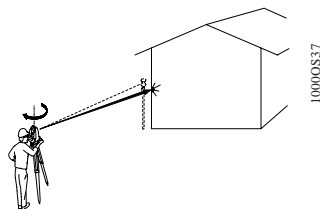

Storing DATA

For calculations which depend on distance, the V-angle after completion of the distance measurement is used, along with the current Hz-direction. Consequently, calculated heights and height differences are retained and the coordinates for easting and northing which correspond to the new Hz direction are recalculated using the last-measured distance.



The V-angle displayed corresponds to the position of the telescope on completion of the distance measurement. The V-angle is not altered until the measurement is recorded, the last recorded point number is recalled, a new distance is measured, or  is pressed.

When distances, heights, or height differences are displayed as empty fields (i.e. -----), the V-angle is continuously displayed and updated.

If, after the distance has been measured, changes are made to the target-point data which have an influence on the distance measured or on the height and height difference (e.g. ppm, prism constant, reflector height, refraction coefficient), the dependent data will be correspondingly verified.

Target-point data



Activates the "**TARGET**" function from the Measurement mode (GSI) dialog.

The following target-point data can be entered here:

- The target point number
- Incremental target point number interval
- Remarks 1 - 9

The function keys are used for:





- Choosing various prisms and retro tape targets
- Defining prism constants
- Entering values used to calculate the atmospheric and geometrical distance corrections
- Entering the refraction coefficient
- Entering manually-measured horizontal distances
- Entering the target-point eccentricity
- Switching from current- to other point numbers.

10

MEAS\ TARGET DATA						14:03
Increment :	102001					
Runn. PtNo :	12A20001					
Refl.Height :	1.500 m					
Remark 1 :	-----					
Remark 2 :	-----					
Remark 3 :	-----					
PRISM	PPM	D	INP	OFFS	INDIV	αNUM
Remark 4 :	-----					
Remark 5 :	-----					
Remark 6 :	-----					
Remark 7 :	-----					
Remark 8 :	-----					
Remark 9 :	-----					



HELP					
F1	F2	F3	F4	F5	F6

-  **F1** Choose the prism from 6 possibilities : Leica circular prism, retro tape target (not in the T/TM versions), Leica 360° prism, 3 user-defined prisms.
-  **F2** Setting the atmospheric ppm and the geometric ppm (height and projection) and the refraction coefficient.
-  **F3** Enter a manually-measured horizontal distance.
-  **F4** Enter the data for an eccentric target point.
-  **F5** Change between individual and running point number.

Remarks

Supplementary information entered (remarks, type of point, topological data etc.) can be stored under "Remarks" .

The remarks must be defined in the recording template. They are stored along with every measurement. The value is retained until it is changed.

If the remarks are defined in the display template, they can be entered directly in the measurement dialog.

Additional information can also be stored in code blocks instead of under "Remarks". For detailed information about the use of additional information, refer to the *chapters "Code information" and "Data format"*.

Incrementing point numbers

The numerical and alphanumerical parts of a point number can be incremented individually. The increment is defined as a numerical mask.

MEAS \ TARGET DATA						14:03
Increment :						102001
Runn. PtNo :						12A20001
Refl.Height :						1.500 m
Remark 1 :						-----
Remark 2 :						-----
Remark 3 :						-----
PRISM	PPM	D INP	OFFS	INDIV	ONUM	
F1	F2	F3	F4	F5	F6	

In the above example, after recording, the next point number is incremented to 12B22002 and then to 12C24003 etc. as shown in the display above.



Letters from A to z (ASCII 065 - 122) can be incremented. This prevents two-way transfer (between letters and digits) within the alphanumeric range.

Examples:

PtNo	12z001	12A999	12Az100
Increment	1000	000001	1001000
Explanation	No transfer of letters to numbers	No transfer of numbers to letters	No transfer of letters

MEAS \ MEASURE MODE (GSI)						14:03
WARNING: 152						
Overflow of running point no. after incrementation.						
Check point no.						
					OK	
F1	F2	F3	F4	F5	F6	



Confirms the warning and the change in the point number or in the increment.

Set and define prisms

 **F1** Activates the "PRISM" function from the "Target point data" dialog.

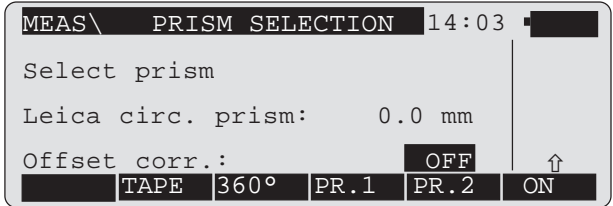

 **Shift**



The active prism is set with the corresponding function key. This action simultaneously sets the relevant prism constants.

IO

Offset corr.

The offset correction is only possible when using a T-version with an EDM attached.

 F6	ON	The correction is to be engaged when using prisms which are standing vertically, in order to correct the measured distance for the offset between the EDM axis and the telescope axis.
	OFF	When using the tilting Leica prism GPH1A this correction is not necessary and must therefore be disengaged.

 **F1** Choose the Leica circular prism (standard setting).



Choose Leica retro tape. The EDM is switched into a mode in which it can measure to retro tape targets. Simultaneously, the corresponding prism constant is set.

T/TM-versions with attachable EDM cannot measure to retro tapes.



Choose the Leica 360° prism. The corresponding prism constant is set automatically.



Choose reflectors from other manufacturers. Only accessible if the prisms are defined.



Define reflectors from other manufacturers. Only accessible with the full range of functions.

MEAS \ PRISM CONSTANTS		14:03
Define prism constants		
Prism name	Value	Prism
Pr. 1	0.0 mm	X
Pr. 2	0.0 mm	X
Pr. 3	0.0 mm	X
		↑
		EDIT



HELP

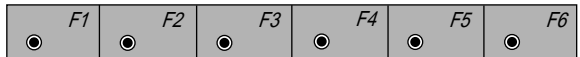

The user can freely define the name and prism constant (additive constant) for three reflectors and can enter the type of reflector (prism or retro tape). The prism constant is always given in millimetres [mm]. It is advisable to determine the prism constant for "non Leica prisms" on a baseline by means of an appropriate procedure.

For the reflector to be available for choice, the constant may not be equal to 0.0.

Prism type:

The symbol of the prism type indicates whether the reflector is to be treated as a prism or as a retro tape.

Move the cursor bar to the column "**PRISM**"



The reflector is set as a **prism**.



The reflector is set as a **retro tape**.

Reduced input of ppm values

For standard applications the distance is corrected **only** on account of atmospheric influences.

The geometrical correction and the projection distortions are set to "0.00". Heights are reduced with the standard refraction coefficient (*see the chapter "Define functionality"*).



Activate the function "**PPM**" from the dialog "Target-point data".

IO

```
MEAS\ PPM CORRECTIONS 14:03
Enter your correction values

Atm. press. : 1013.3 mbar
Temperature : 12.0 °C

ppm total : -0.0
EDIT
```



HELP

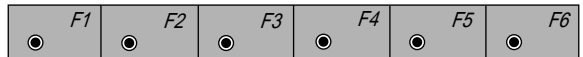

Input of air pressure and temperature

or

Input of ppm value.

The values for pressure and temperature are erased.



The dialog is dependent on the setting within "FUNCTIONALITY".

Comprehensive distance corrections (ppm)

A distinction is made between atmospheric (ppm) and geometric (ppm) corrections, the sum of which is used as the final distance correction.

• Atmospheric correction

The atmospheric distance corrections are derived from the dry-air temperature, air pressure or height over mean sea-level, and relative air humidity or wet-air temperature.

MEAS \ ATMOSPHERIC CORR.		14:03			
Temperature :	12.0	°C			
Atm. press. :	1013.3	mBar			
Temp.wet-b. :	0.0				
ppm atmospheric :	0.0				
ppm geometric :	0.0				
ppm total :	0.0				
GEOM	REFRA	P<>E	%<>T'	ATM=0	EDIT
HELP					
<input type="radio"/> F1	<input type="radio"/> F2	<input type="radio"/> F3	<input type="radio"/> F4	<input type="radio"/> F5	<input type="radio"/> F6



Settings for the geometrical correction.



Settings for the refraction correction.



Toggle between air pressure and height above mean sea-level.



Toggle between relative air humidity and wet-air temperature.



Set the atmospheric ppm to "0.00". (Individual parameters are set to the standard atmospheric values, corresponding to the atmospheric correction ATM=0)



The dialog is dependent on the setting within "FUNCTIONALITY".

- **Geometrical correction**

The geometrical distance correction is derived from the projection distortion and the height above the reference datum.

The calculation of the geometrical ppm follows the formula for the Transversal Mercator Projection. The individual factors are: the scale factor of the line of projection (central meridian, Gauss-Krüger = 1.0, UTM = 0.9996, etc.); the offset from the line of projection; the height above the reference datum (normally this is the height above mean sea-level); and an additional individual scale correction.



The distance without any projection distortion is used to determine the height difference. The individually-set scale adjustment is always applied to the distance.

The individual scale correction can be used to enter a total geometrical correction.

MEAS\ GEOMETRIC CORR.		14:03
Scale C.M. :	1.0000000	
Offset C.M. :	51000 m	
Height aRef :	350 m	
Indiv. ppm :	0.0	
ppm geometric:		-22.9
		GEO=0 EDIT
ppm ref. level :		0.0
ppm map projection :		0.0



HELP					
F1	F2	F3	F4	F5	F6



Sets the geometrical ppm to "0.00". The scale on the Central Meridian is set to "1.0000000". The other parameters are set to "0.00".

- **Refraction correction**

The refraction correction is taken into account during the calculation of the height difference.

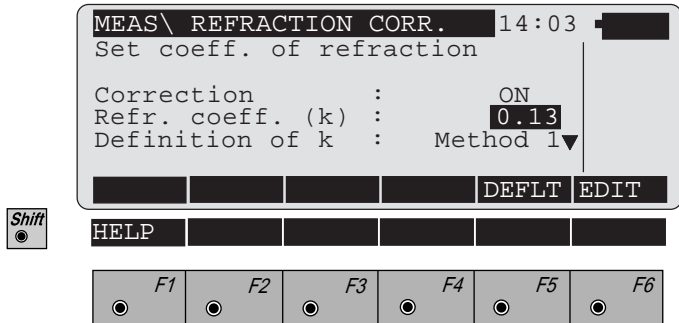

F5 Sets the refraction coefficient to standard values.
(**Method 1:** k = 0.13, **Method 2:** k = 0.07)

F6 **Correction ON/OFF** | Turns the refraction coefficient on and off.

Refr. coeff. (k)
EDIT | Enters a new value for k.

Definition of k
LIST | Defines k.

Selecting the method of calculating the refraction correction. Both methods calculate the same result with different input values.

Method 1: $\frac{1 - k}{2R}$ (Standard value k = 0.13)

Method 2: $\frac{0.5 - \frac{k}{2}}{R}$ (Standard value k = 0.07)

Manual distance entry

Enter the horizontal distance, which was measured with a tape for instance. Immediately after confirmation of input, the horizontal distance is shown corrected for the geometrical ppm. After the distance has been entered, the V-angle is set to "horizontal" 90° (100 gon) or 270° (300 gon). The coordinates are calculated using the corrected horizontal distance, the Hz-direction, and the V-angle. Heights are always corrected for earth curvature and are corrected for refraction according to the parameter settings.



Activates the dialog which allows the horizontal distance to be entered manually.

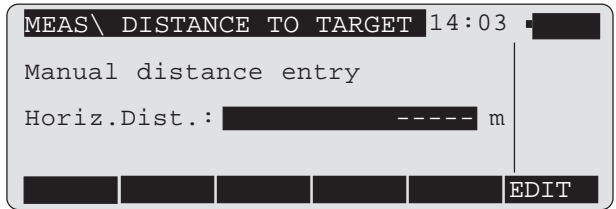

IO



The reflector height is temporarily set to the value for the instrument height and so there is always a height difference of "0.000".

The slope distance is the same as the horizontal distance.

Target eccentricity

If the reflector cannot be set up directly, or if it cannot be seen from the instrument, the values for eccentricity can be entered. All of the displayed and stored values are calculated in relation to the centre.



Each time that data is stored, the values are automatically reset to "0.000".



Activates the function "OFFS" in the dialog "Target-point data".

MEAS \ OFFSET DATA		14:03
Enter offset data		
Shft length:	0.000	m
Shft trans :	0.000	m
Shft height :	0.000	m
		DEFLT EDIT
HELP		
F1	F2	F3
F4	F5	F6

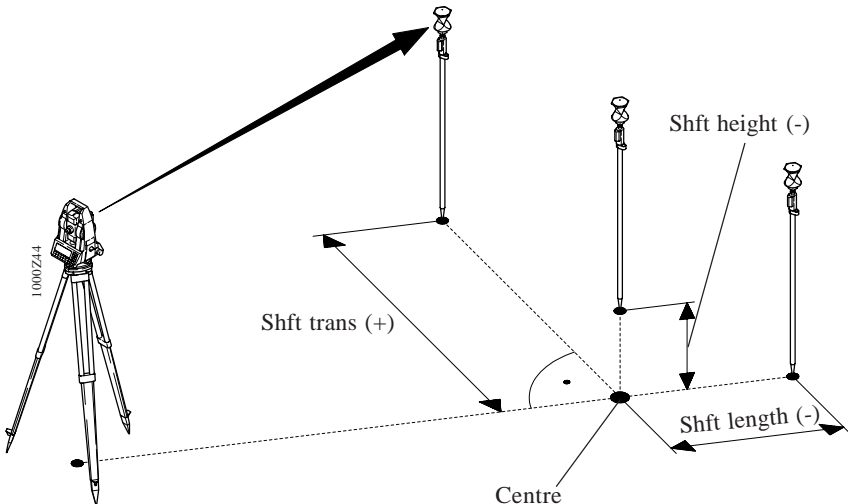

Individual point number

MEAS\ TARGET DATA					14:03
Increment :	102001				
Runn. PtNo :	12A20001				
Refl.Height :	1.500 m				
Remark 1 :	-----				
Remark 2 :	-----				
Remark 3 :	-----				
PRISM	PPM	D INP	OFFS	INDIV	αNUM

Shift

HELP

F1	F2	F3	F4	F5	F6
----	----	----	----	----	----

F5

Toggles between running ("RUNN") point number and individual ("INDIV") point number.

Set station data

Select user template and measurement file



Activates the "SETUP" function from the main menu. Choose the data carrier for storing the data, the user setting, and the measurement- and data files.

SETUP\ START-UP DISPLAY 14:03					
Select user template & files					
User templ.: Polar(Standard) ▾					
Rec. device: Memory Card ▾					
Meas. file :1 √ FILE01.GSI ▾					
Data file :2 √ FILE02.GSI ▾					
			ORI	STAT	LIST
HELP					
F1	F2	F3	F4	F5	F6



IO

Station entry/setting

The coordinates of a station point are set. A known direction to a tie point can be entered.



Activates the function "STN" from the dialog "START-UP DISPLAY".

SETUP\ STATION DATA 14:03					
Station no.: 1					
Inst. Height: 1.520 m					
Stn. Easting: 100.000 m					
Stn. Northng: 2000.000					
Stn. Elev.: 500.000 m					
HZ: 222°42'33" ↑					
		REC	Hz0	IMPOR	αNUM
HELP				VIEW	
F1	F2	F3	F4	F5	F6



After the point number of the station point has been entered, the coordinates can be input directly using the numeric keys or can be imported from the data file of the memory card.

Recording station data



The station data (point number, easting, northing, station height, reflector height and instrument height) are recorded in the measurement file of the active data carrier. The coordinates are set as station coordinates.



The coordinates displayed are set as station coordinates.

In both instances there is a jump to the "MAIN MENU" dialog. "Measure mode" can be activated there with .

Setting and entering Hz direction (Hz0)



Set Hz direction to 0° 00' 00" (0.0000 gon) or enter a known value.

Target the tie point exactly.
The direction must always be set using face I.
Enter the new direction to the tie point.

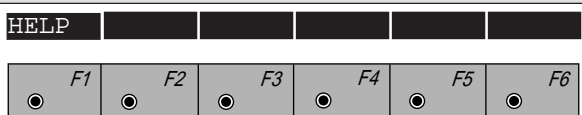
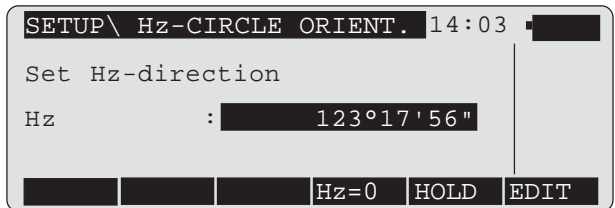

Sets Hz to 0° 00' 00" (0.0000 gon).

Instead of entering a value, this can be set by turning the instrument.



Secures the value (clamp the circle)

Target the tie point exactly.



Releases the circle.



This function is also activated from other dialogs in order to enter the Hz direction.

Import point data (Import function)

As well as the measuring mode, the function "Import point data" has a special significance, because it is also used in many applications. This function enables **point coordinates** to be read from the data file and transferred to the application currently in use.

10

The screenshot shows the "SETUP\ STATION DATA" dialog box with the following data:

Station no.:	1	
Inst. Height:	1.520 m	GSI
Stn. Easting:	100.000 m	
Stn. Northng:	2000.000	
Stn. Elev.:	500.000 m	
HZ:	222°42'33"	↑

Below the dialog box are several function keys:

Shift	HELP			VIEW	
F1	F2	F3	F4	F5	F6



Direct data search

After the complete point number has been entered, the coordinates of the first data set (the search always starts at the beginning of the file) are accepted for the application. The data set found is generally not displayed and the appropriate application activates the subsequent dialog.¹

¹ The dialog "STATION DATA" is an exception to this rule and the coordinates there are displayed.



Controlled data search

After the complete point number has been entered, the coordinates of the first data set found are displayed (The search always starts at the beginning of the file).

Point found:

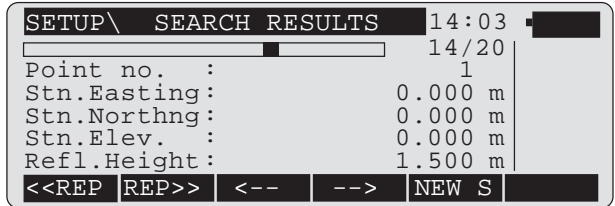

Inst. Height : 0.000 m



HELP



The first line contains the scroll bar which graphically displays the position of the data block within the data file, as well as the data block number in relation to the total number of data blocks within the file.



Repeat the point number search in the direction of the beginning of the data file in order to look for points which have been recorded more than once with the same point number or with placeholders.



Repeat the point number search in the direction of the end of the data file in order to look for points which have been recorded more than once with the same point number or with placeholders.



Sequential display of the points (upwards within the file).



Sequential display of the points (downwards within the file).



Starts a new point search. The function proceeds as after an unsuccessful point search.



Accepts the displayed value for the appropriate function or application.

Point not found:

If no points are found then the error message **ERROR 1355** is displayed, which means that no points have been found with the given point number in the file.

Confirm this with the  key - the user will be prompted to enter the point number again.

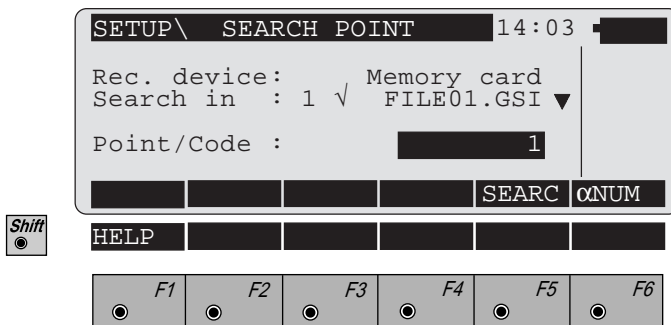

10

The file for the data search can be changed and/or a new point number can be entered



Direct data search

After the complete point number has been entered, the coordinates of the first data set (the search starts at the beginning of the file) are accepted by the application. The data set found is not generally displayed and the appropriate application activates the subsequent dialog.¹

Controlled data search

The coordinates of the point are displayed. To continue, see "Controlled data search" on page 85.

¹ The dialog "Station data" is an exception to this rule and the coordinates in it are displayed.

Placeholder (wild cards)

The search for stored data can be made easier if a placeholder is used instead of the complete point number. In the TPS1000, a decimal point "." is used instead of the more usual star "*", because it is more easily entered. There is no entry corresponding to "?".

Example of the use of placeholders:

Input	Results	Remarks
11.	11, 110, 1101, 11ABC5, 111111	After 11 there can be any character and in any amount.
.11	11, ABC11, 11111	Before 11 there can be any character and in any amount.
1.0	10, 100, 1ABCD0, 11111110	Between 1 and 0 there can be any character and in any amount.
.10.	10, 3410ABC, 111110, 1000000	A 10 must be present at least once .
.1.0.	10, 341ABC0, 1123Z0Y, 1001A000	A 1 must be present in front of a 0 at least once , and any amount of characters can be present between them.

If a number with placeholder is entered instead of the complete point number, the **controlled data search** is always started and the first matching data set is displayed. The subsequent procedure is the same as that used when entering a complete point number.

1-point orientation

All of the entries relevant to a new instrument configuration are summarized in this function and can be dealt with very quickly.



Activate the function in the dialog "START-UP DISPLAY" (page 82).

SETUP \ 1-PT. ORIENTATION 14:03					
Station	:			1	
Backsight	:			A	
Inst.Height:			1.500	m	
Refl.Height:			1.000	m	
Δ Hz-Dist.	:		----	m	
↑					
ALL	DIST	REC	INPUT	αNUM	
HELP			I<>II	VIEW	
F1	F2	F3	F4	F5	F6



Enter the numbers of the station point and of the backsight point respectively. The appropriate point is immediately searched for in the data file and, if the search is successful, the coordinates will be assigned to the station point and backsight point without this fact being displayed.

After the instrument height and the reflector height have been entered, target the backsight point and measure the distance and/or the direction.





Measure the distance and determine the direction, and store the measurement block. The graduated circle is orientated. The difference between the calculated distance and the measured distance to the backsight point is displayed.





Measure the distance. The difference between the calculated distance and the measured distance to the backsight point is displayed.

 **F3** Determine the direction and store it, including the previously-measured distance where appropriate. The graduated circle is orientated.

 **CONT** Determine the direction, but do not store the values. The graduated circle is orientated.

 **F5** Using the keyboard, enter the coordinates for the station or for the tie point. *See chapter "Data management"*.

  **F5** Activate controlled data search within data file. *See chapter "Data management"*.

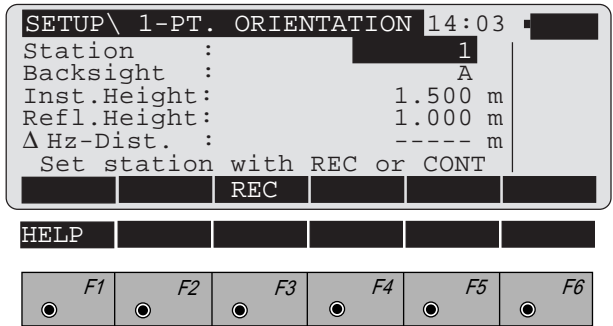

 **F3** Station data are set and are stored in the measurement file.

 **CONT** Station data are set.

In both of these cases, there is a jump to the main menu, from where the measuring mode can be called by using  .



Activates the "DATA" function from the "MAIN MENU".

Using data management, the user has the possibility to display data from within a chosen data file, or to delete data blocks or data files.

Point numbers, codes and remarks can be edited.

Individual points, and points saved several times with the same point number, can be searched for, displayed, and deleted.

When calling up the function, the last point number will automatically be displayed in the file at "Point/Code" file.

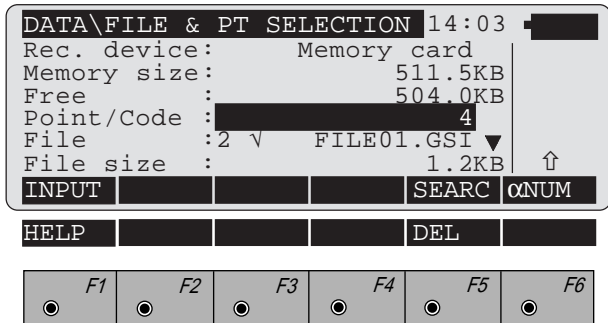







Entering coordinates

 **F1** Enters point coordinates in the data file.

DATA\ MANUAL ENTRY		14:03
Enter coordinates		
Data file	: 2 ✓	FILE02.GSI ▼
Indiv.PtNo	:	5
Easting	:	----- m
Northing	:	----- m
Elevation	:	----- m
		EDIT

 **Shift**

HELP

 F1	 F2	 F3	 F4	 F5	 F6
---	---	---	---	---	---







The height is only stored if a value has been entered.

IO

Deleting data

  **F5** Deletes the current data file.

DATA\FILE & PT SELECTION		14:03
WARNING: 1352		
File FILE01.GSI will definitely be deleted!		
Do you really want to delete?		
		NO
		YES

 F1	 F2	 F3	 F4	 F5	 F6
---	---	---	---	---	---

 **F3** The file will not be deleted.

 **F5** Confirms deletion of the data file.

View data



Activates the function from the dialog "DATA FILE/
SELECT POINT".

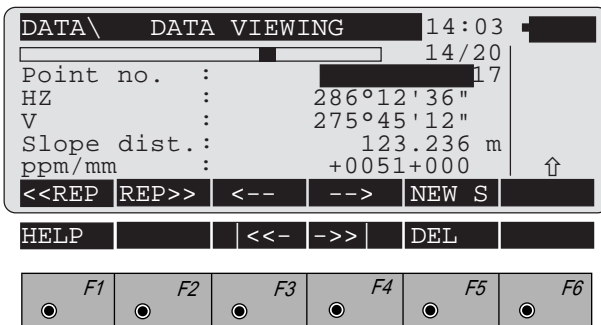

The data is shown point by point, in accordance with the template used at the time of the recording. The data displayed can therefore vary, depending on the point currently being considered.

The subsequent procedure, and the options for entering point numbers, are the same as with the function "Import data", with the exception of the following functions:



Jumps to the beginning of the data file. This key is not assigned if the point displayed is the first in the data file.



Jumps to the end of the data file. This key is not assigned if the point displayed is the last in the data file.

Edit data

If the editing of data is permitted by the range of functions, then point numbers, code information, remarks etc. can be altered. True measurement data, such as directions and distances, cannot be altered.

Leica prisms and retro tapes

Prism for attachable EDM

When using the theodolite in connection with DI1001, DI1600, or DI2002 EDMs for measuring over short distances, we recommend using the GPH1A single-prism holder.

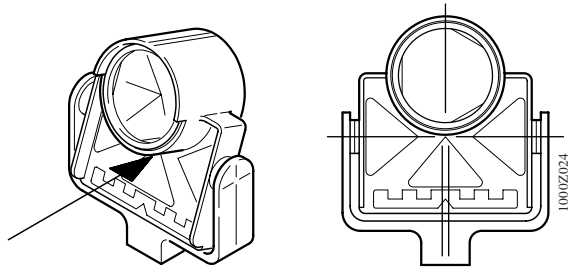

GPH1A single-prism holder

IO

The height difference between the telescope's optical axis and the infra-red beam is corrected by the corresponding difference at the target, therefore **aim the crosshairs at the yellow target mark**.

The GPH1Z / GRZ3 single-prism holder is recommended for measurements with the DI3000.

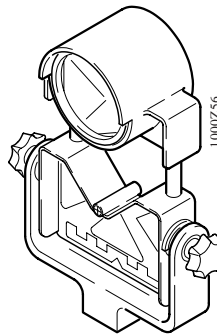

GPH1Z/GRZ3 single-prism holder

***Prism for incorporated
EDM***

For measuring distances we recommend using the GPH1 single-prism holder. The intersection of the vertices of the prism lies exactly at the intersection of the rotation axes of the reflector and can therefore be used directly as the target. For perfect targeting of the GPH1 over longer distances the additional GZT4 target is recommended. The EDM telescope is adjusted during manufacture so that the measuring beam lies exactly on the optical axis.

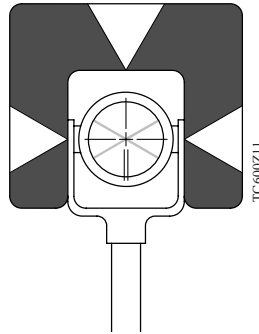

GPH1 single-prism holder with GZT4 target plate

Aim the crosshairs at the centre of the reflector. TCA models are able to aim automatically at the centre of the prism.

The GRZ4 360° reflector

The GRZ4 reflector is a special 360-degree prism and is available as an option. It allows measurements and **automatic target recognition** from any direction. Since it does not always need to be turned towards the instrument, the reflector provides additional comfort for a rodman and improved surveying efficiency.

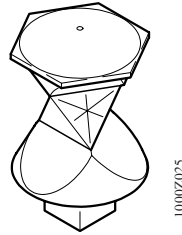

The grouping of the 6 prisms of the 360° reflector makes

- the accuracy of horizontal measurement and
 - the accuracy of vertical measurement
- with automatic target recognition **independent** of the position of the reflector.

The overall positioning accuracy of the reflector is ± 5 mm in distance and ± 5 mm for the angle (horizontal and vertical). When the arrow on the upper rubberized mount points towards the instrument and therefore the front face of a prism points towards the EDM, the accuracy is improved.

The GRZ4 reflector is highly recommended for topographic and stake-out surveys. Leica circular prisms are recommended for surveys requiring higher accuracy than that provided by the GRZ4 prism.

Leica retro tapes

Retro tapes can be attached permanently to an object for the purposes of monitoring or for frequent repeat measurements. A retro tape may also be useful for the once-and-for-all marking of a point which is difficult to access.



The retro tapes should always be attached in the preferential direction (Leica logo readable acc. to fig.).

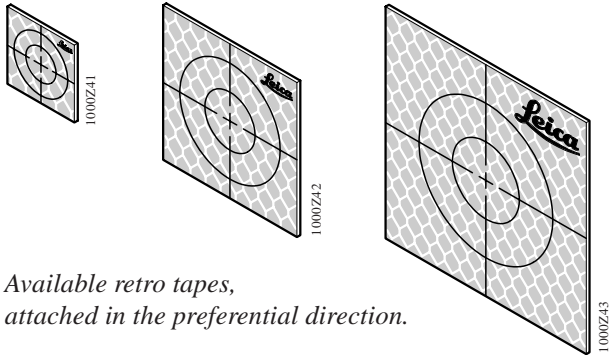

Available retro tapes,
attached in the preferential direction.

Special features

- Range up to 180m (600ft)
- No loss of accuracy when retro tape is perpendicular to the line of sight
- Measurement precision $\pm 3\text{mm}$ when retro tape is at 45° . This precision can be increased by measuring in two positions.
- For short ranges of up to 10m (33ft) the additional lens 632 364 is required. (Measuring error without additional lens $> 10\text{mm}$). It is important that the additional lens is placed to the instrument in the correct position (see fig.).

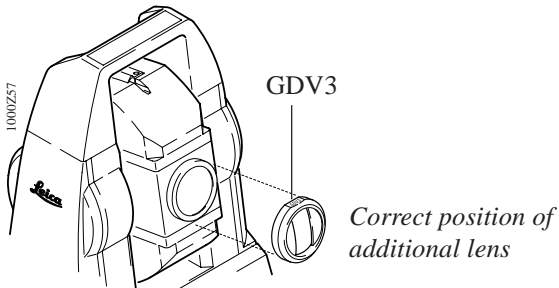

Technical data for measurements to retro foils

Target-mark size [mm]	Range [metres]	Accuracy * (standard deviation)
20 x 20	2 to 40	3 mm
40 x 40	20 to 100	3 mm
60 x 60	60 to 180	3 mm

* The accuracies quoted are valid when the retro tape is targeted at an angle of up to 45°.

Summary



Prism	Prism constant
Leica circular prism	0 mm
Leica retro tape	+34.4 mm
GRZ4 360° reflector	+23.1 mm

IO

The prism constant is set automatically when the correct type of reflector is used.

If another make or type of prism is used it is advisable to determine the constant on a calibration range.



Take care when pointing through windows or if reflective surfaces are present in the field of view. Incorrect readings may result.

Other reflectors for precision measurement and for special applications are also available. Please contact your Leica agency.

Long distances

Over longer distances or in inclement meteorological conditions it is better to use the GPH3 three-prism holder or the GPH11 eleven-prism holder, with the corresponding number of reflectors, irrespective of whether the EDM is attachable or already built in.



Activates the "**EXTRA**" function in the main menu.

The following display refers only to TCA versions. All other versions lack the "Remote control mode".

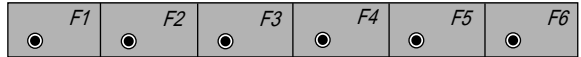
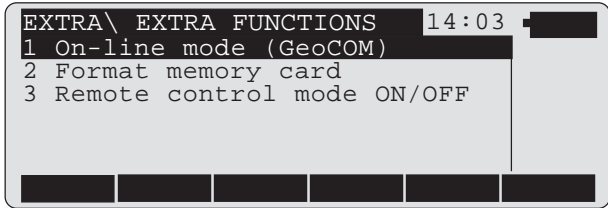

On-line mode

With on-line operation (GeoCOM), the instrument is switched to a mode which permits communication with, or control by, a data recorder or PC. This mode operates across the RS232 interface; the GeoCOM command set is used.

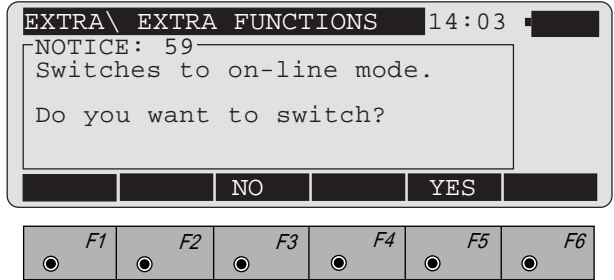

Returns to the "MAIN MENU" dialog.



Activates the "On-line mode". The operation of the instrument is now totally controlled across the interface. For information about data structures, and for the detailed structure of the control commands, please refer to the "GeoCOM Reference Manual" (*G-560-0en*), which is available only in English. The on-line mode can be quitted only by pressing  .

Format a memory card

This function can be password-protected. To call the function, first enter the password.

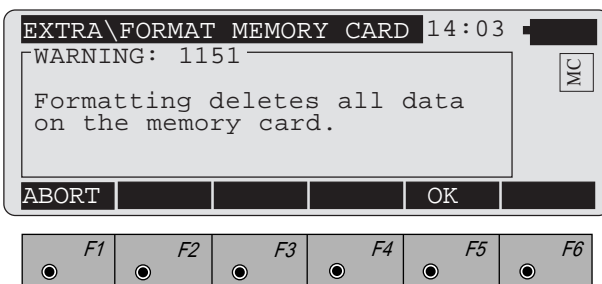

When the memory card is re-formatted, all data on it are irretrievably lost.



Ends the function of formatting a memory card and returns to the "MAIN MENU".



Confirms that the formatting is to go ahead. The storage capacity of the memory card is ascertained and the card is formatted accordingly.

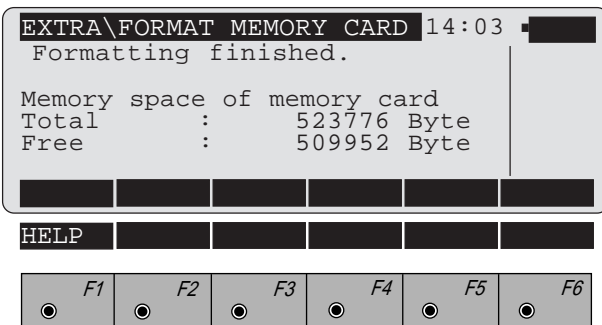

Once the card has been formatted, the total memory on the card and the amount available to the user are shown on the display. The difference in these amounts relates to the memory used to manage the files and directories.

Remote-control mode

This option switches the instrument into a mode (**TCA models only**) to control the operation via a radio modem or cable from a control unit. All functions, programs and information are transmitted from the instrument to the RCS or from the controller to the instrument. With the help of the remote-control mode it is possible to survey solo. *See chapter "Remote-Controlled Surveying".*

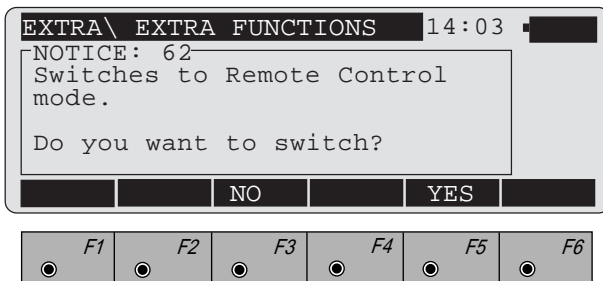

F3

Returns to the "MAIN MENU" dialog.



F5

Activates the remote control mode.

Configuration

The configuration of the TPS 1000 enables the instrument to be matched to user requirements. Many of the settings need to be adjusted just once, before the instrument is first used. Others can be changed when the instrument is used for a completely-different purpose.

The instrument is delivered with a configuration which has a reduced range of functions. This simplifies its use for standard surveying applications.

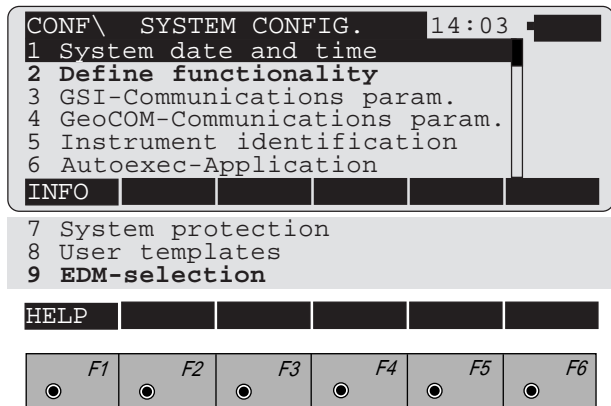

The following parameters can be set:

- date and time
- defining the functionality
- the GSI communication parameters
- the GeoCOM communication parameters
- the instrument name
- the auto-start application
- the password and parameter for the system protection
- the user templates
- the type of add-on EDM (for **T- and TM-models**)

In the submenu "User configuration" are set:

- user password
- display screen
- recording screen
- the number of characters for storage
- the names of the user templates
- system language
- units for distance measurements
- the decimal places for display and storage
- units for angle measurements
- units for temperature entries
- units for pressure entries
- display of coordinates
- direction of the horizontal angle measurements
- definition of the telescope face.



The above dialog is dependent on the definition of the functionality.

The following options are available in the reduced menu structure:

- Functions where the cursor bar is positioned
- Functions in **heavy** type (this does not apply to the instrument itself).

All of the displays which are unaffected by the functionality are displayed without heavy type.



Shows the version number of the system software.

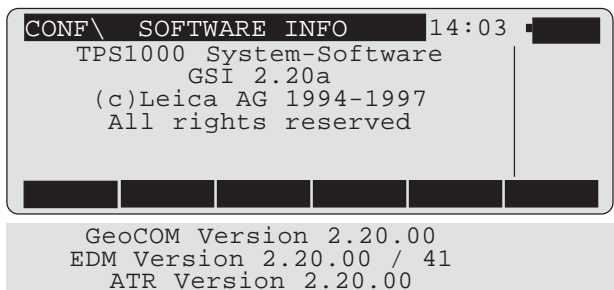



Activates the function from the "SYSTEM CONFIG." dialog.

CONF\ SYSTEM CONFIG.		14:03
Set date and time		
Date	: 14.01.96	DMY▼
Time	: 16:32:47	24h▼
		EDIT



HELP					
F1	F2	F3	F4	F5	F6

The editing follows the general rules described in the chapter "Operating concept". Additionally, the point in the date and the colon in the time can be skipped during editing, by using the key.

Date DMY (day, month, year)
 MDY (month, day, year)

Time 12h (12-hour display)
 24h (24-hour display)

The 12-hour time display indicates with an "a" the time before 12 o'clock and with a "p" the time after.

- 2 Activates the function from the "SYSTEM CONFIG." dialog.

The range of functions available in the TPS1000 can be defined. The instrument is delivered with a configuration which has a reduced range of functions.

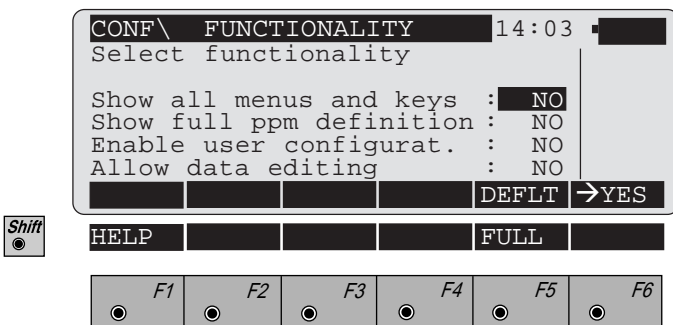

Show all menus and keys

YES	All functions can be activated.
NO	The range of functions which can be called is reduced. Functions which are always available are indicated in heavy type in the dialogs.

Show full ppm definition

YES	Meteorological and geometrical corrections can be entered and a scale factor can be taken into account. For height calculations, a refraction coefficient which differs from the standard value can be entered.
------------	---

NO	Only pressure and temperature, or a ppm-correction of the distance measurement, can be entered. Geometrical corrections and a scale factor are not taken into account. Heights are calculated using the standard value for refraction.
-----------	--

Enable user configuration

YES	The user setting can be changed.
NO	The user setting cannot be changed, but a user setting can always be selected.

Allow data editing

YES	Stored data such as point numbers or code blocks can be altered. Measurement data such as angles, distances or coordinates cannot be altered. The alteration is carried out within the function "Editing data".
NO	Stored data cannot be altered.



Sets all settings to **NO**.



Sets all settings to **YES**.

**Interface parameters
(GSI)**



Activates the function from the "SYSTEM CONFIG." dialog.

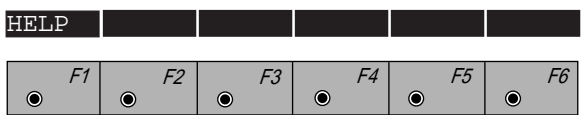
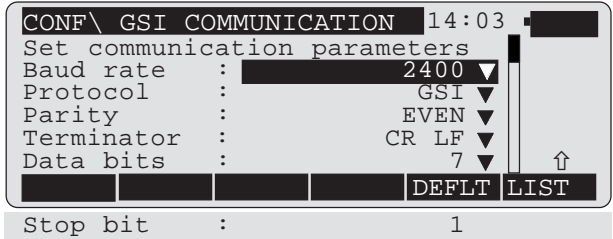

The communication interface parameters set here are only applicable to the GSI data format in local mode and in remote-control mode. The baud rate can be chosen from the standard values between 2400 and 38400.

IO



The standard parameters are shown *above*.



Opens a list of possible parameters applicable to the field with the highlighted bar.

For more detailed information about command- and data structure, please refer to "WILD Instruments On-Line" (document no. G-366-0en), a copy of which is available (in English only) from your local Leica agency.



With the exception of the settings for "Protocol", the values are retained after the instrument has been switched off. When it is switched on again, the value for the protocol is always set to GSI.





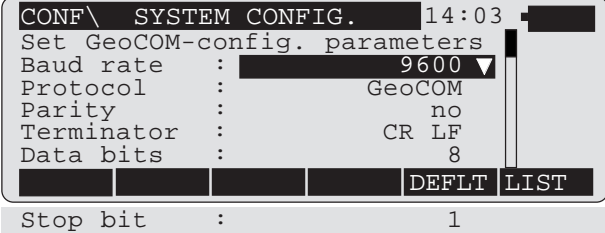

Interface parameters (GeoCOM)

-  4 Activates the function from the "SYSTEM CONFIG" dialog.





```
CONF \ SYSTEM CONFIG. 14:03
Set GeoCOM-config. parameters
Baud rate : 9600
Protocol : GeoCOM
Parity : no
Terminator : CR LF
Data bits : 8
DEFLT LIST
Stop bit : 1
```

 **HELP**

 F1	 F2	 F3	 F4	 F5	 F6
--	--	--	--	--	--

The settings of the interface parameters are valid for communication using the "GeoCOM command structure". The baud rate can be chosen from a list of standard values between 2400 and 38400. All other parameters are fixed and cannot be changed.

-  F5 Sets the baud rate to the standard value of 9600 baud.
-  F6 Opens the list field in order to choose the baud rate.

For more detailed information about command- and data-structure, please refer to the handbook "*GeoCOM Reference Manual*" (document no. G-560-0en), a copy of which is available (in English only) from your local Leica agency.



Activates the function from the dialog "SYSTEM CONFIG".

Displays the instrument name, type, and serial number. The instrument type and serial number are set at the factory and cannot be changed.

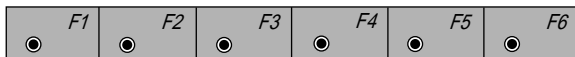
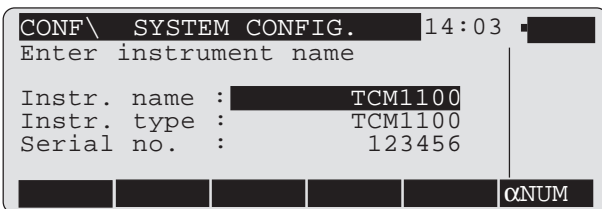

Enters a user-defined instrument name. Up to 16 characters can be used for the instrument name.



Activate the function from the "SYSTEM CONFIG" dialog.

Choose the application which is to be started automatically when the instrument is switched on.

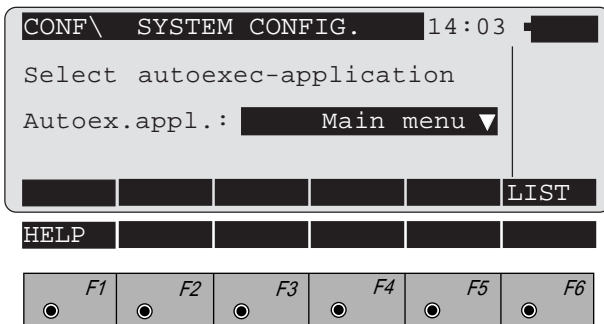

Choose the application which is to be automatically started when the instrument is switched on.

The list of choices contains the permanent options "Main menu", "Meas & Rec (GSI)" and "SETUP". Additionally all loaded application programs are listed. The chosen function/application is started automatically every time the instrument is switched on.

System protection

-  Activate the function from the "SYSTEM CONFIG" dialog.

You can protect several functions by assigning to each the system password. Only by using the system password can a user gain access to these functions, which are: "Format a memory card, delete a file, delete a data block, edit the functionality".

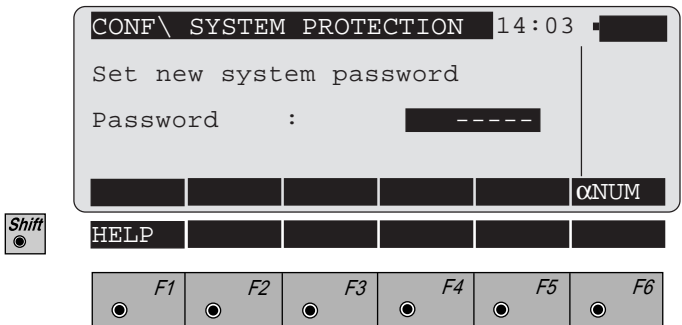

-  Enters an alphanumeric password up to 8 characters in length. If a password has not already been assigned then one can be entered without further problems. If a password has already been assigned it must be entered at this point to enable parameters to be changed.

The individual system-protection parameters can be set or reset in the following display. The password can be changed or deleted as well.

CONF \ SYSTEM PROTECTION 14:03	
Set system protection param.	
Function	Status
Format mem. card	free ▼
Delete GSI file	free ▼
Delete GSI block	free ▼
	PWD
	DEFLT
	LIST
Edit Functionlty	free ▼
HELP	
F1	F2
F3	F4
F5	F6

Shift

F3

Change the existing password.

CE

Delete the existing password. If the password was deleted, **CONF** will bring you directly back to the main menu.

F5

Sets the standard values to be "free".

F6

Opens the list field in order to set the individual protection parameters to either "protected" or "free".

User configurations

Various setting adjustments can be performed in order to match the instrument to the requirements of a particular survey application.

The accuracies, the data to be stored and the values to be displayed for a topographic survey are different from those needed for monitoring a dam. The settings can be defined for a maximum of five typical "applications" and stored for later recall.



Activate the function from the "SYSTEM CONFIG" dialog.

The settings valid for the application are displayed.

CONF\ USER CONFIGURATION 14:03				
Current user template:				
User templ.: Polar(Standard)▼*				
Language : ENGLISH				
REC Format : GS18 (8 char)				
Distance : Metre 3 Dec.				
Angle : 360° ' " 3 Dec.				
RMASK	DMASK	SET		LIST
Temperature : °C				
Atm. press. : mbar				
Coord. displ: Easting/Northing				
Hz-system : Clockwise (+)				
Face I : V-drive left				

IO



HELP					
F1	F2	F3	F4	F5	F6



Selects a different user template¹ and displays the values which are valid.



* after "User templ" means that the current user template is password-protected.

¹ There is a choice of five user templates.

The user configuration includes:

- the recording template
- the display template
- other settings such as units, number of digits.



Alters the recording template:

Certain data are defined for storage and use in the user configuration for each measurement. These data are stored in up to 12 "words" (*see chapters "Setting the recording template", page 116, and "Data format"*).

CONF\DEFINE RECORD MASK				14:03	
User templ.: Polar(Standard)					
1st word	:11	Point no.			
2nd word	:21	Hz	▼		
3rd word	:22	V	▼		
4th word	:31	Slope dist.	▼		
5th word	:51	ppm/mm	▼		
		A-DEF	C-DEF	P-DEF	LIST

Shift	HELP				
-------	------	--	--	--	--

F1	F2	F3	F4	F5	F6
----	----	----	----	----	----



Alters the display template:

Certain data are defined for display in the user configuration of the measurement dialog. Up to 11 lines in the measuring dialog can be defined (*see chapter "Setting display template", page 118*).

CONF\DEFINE DISPLAY MASK				14:03	
User templ.: Polar(Standard)					
Line 1	:11	Point no.			
Line 2	:71	Remark 1	▼		
Line 3	:87	Refl.Height	▼		
Line 4	:21	Hz	▼		
Line 5	:22	V	▼		
				DEFLT	LIST

Shift	HELP				
-------	------	--	--	--	--

F1	F2	F3	F4	F5	F6
----	----	----	----	----	----



F4 Alters the remaining settings (see chapter "Editing various user parameters", page 121).

```

CONF\ USER CONFIGURATION 14:03
Password      : SECRET
User templ.  : TOPOGR.
Language      : ENGLISH
REC Format    : GSI8 (8 char)
Distance     : Metre   ▼ 3 Dec.▼
Angle        : 360° '  " ▼ 3 Dec.▼
RMASK        DMASK        DEFLT  LIST
  
```

Shift

HELP

F1 F2 F3 F4 F5 F6

If a user template is password-protected, this password must be entered before the parameters can be changed. In this case the following dialog will appear after **F2**,

F3 or **F4** :

```

CONF\ TEMPLATE PASSWORD 14:03
function is password protec-
ted.

Enter template password
Password : -----
                                QNUM
  
```

Shift

HELP

F1 F2 F3 F4 F5 F6

IO

Setting the recording template

 **F2** Activates the function "REC MASK".

The point number cannot be changed. The other 11 lines can be set using the recording data from a list which is similar to the list for setting the screen.

CONF\DEFINE RECORD MASK 14:03

User templ.: Polar(Standard)

1st word :11 Point no.

2nd word :21 Hz ▼

3rd word :22 V ▼

4th word :31 Slope Dist. ▼

5th word :81 Easting ▼

A-DEF C-DEF P-DEF LIST

6th word :82 Northing ▼

7th word :83 Elevation ▼

8th word :51 ppm/mm ▼

9th word : 0 (empty) ▼

10th word : 0 (empty) ▼

11th word : 0 (empty) ▼

12th word : 0 (empty) ▼

Shift

HELP

F1 F2 F3 F4 F5 F6

 **F3** Selects the standard recording template for storing directions, distances and coordinates.

11	Point number
21	Hz
22	V
31	Slope distance
81	Easting
82	Northing
83	Elevation
51	ppm/mm



Chooses the standard recording template for storing coordinates.

11	Point number
81	Easting
82	Northing
83	Elevation



Chooses the standard recording template for storing direction, distance and ppm.

11	Point number
21	Hz
22	V
31	Slope distance
51	ppm/mm



Opens the list of choices of display data, for changing the display template. For details, see *"Types of field"*.

In contrast to the display template, the parameters in the recording template can be set only once.



If information needs to be stored as remarks, it must be defined in the recording template. If the remarks are also defined in the display template, the information can be altered directly in the measuring dialog. Otherwise remarks can be entered in the **"TARGT"** option in the measurement data display.



The standard REC templates are different from the standard display template. The REC template does not include the reflector height, for example. If the heights of targets are to be inspected in the office, the word **"Refl. Height"** must be added to the recording template.

Complete list of display and recording parameters



Differences between recording and display screens are specially indicated.

(*) = only on the display screen

0	(empty)	• Empty line
(*) 2	Station-No.	• Station point number (alphanumeric)
84	EastingStat.	• Station easting co-ordinate (Yo)
85	NorthingStat.	• Station northing co-ordinate (Xo)
86	Height	• Station height (Zo)
88	Instr.Height	• Instrument height
11	Point-No.	• Target point number (alphanumeric)
81	East	• Target point easting co-ordinate (Y)
82	North	• Target point northing co-ordinate (X)
83	Height	• Target point height (Z)
87	Refl.Height	• Reflector height
(*) 41	Code	• Code blocks serve to record additional information used in further processing of the measurement data. The codes are stored in blocks separate from the measurement data blocks and contain at least one CODE-word and up to 7 more information words (Info 1 to 7). Each of these editable information words can contain up to 8 or 16 alphanumeric characters.
(*) 42	Info 1	
(*) 43	Info 2	
(*) 44	Info 3	
(*) 45	Info 4	
(*) 46	Info 5	
(*) 47	Info 6	
(*) 48	Info 7	
71	Remark 1	• Remarks (1-9) serve as CODE-words (Code, Info 1-7) as additional information used for further processing of the measurement data. Alphanumeric information for the remarks (1-9) can be entered in the " TARGET " option in the measurement display. Each of the editable remarks can contain up to 8 or 16 alphanumeric characters. Contrary to CODE-words, remarks are stored within the measurement data block, so long as the recording template is so defined.
72	Remark 2	
73	Remark 3	
74	Remark 4	
75	Remark 5	
76	Remark 6	
77	Remark 7	
78	Remark 8	
79	Remark 9	
21	Hz	• Horizontal direction
22	V	• Vertical angle
31	Slope dist.	• Measured slope distance (already corrected using ppm and prism constant)

- 32 Horiz.dist. • Horizontal distance (reduced slope distance)
- 33 Height diff. • Height difference between the station point and the target point with allowance made for the instrument and reflector heights
- 51 ppm/mm • Total ppm-correction and prism constant
- 52 n / s • Number of averaged distances measured and the standard deviation in millimetres
- 58 Add.-const. • Prism constant
- 59 ppm total • Total ppm-correction
- (*) 1 Last PtNo • Last point number recorded (*)
- 12 Instr.-No. • Instrument serial number
- 13 Dev.type • Device type (e.g. TCM 1100)
- 18 YY ss.sss • YY = Year, ss.sss = seconds. The decimal places are filled with zeroes.
- 19 MM DD hh • MM = Month, DD = Date, hh = hours, mm =
mm minutes (current system date and time)



Display and recording parameters can be defined independently. Therefore make sure that the recording template contains all parameters necessary for evaluation.



If values "Easting" and then "Northing" are defined in the display mask and if the coordinate display shows "Easting/Northing" then also the Easting value followed by the Northing value appears in the measurement mode. However, in connection with the display mask and the display in the measurement mode four cases must be considered:

DMASK	Coord. disp.	Display in measurement mode	Change
Easting/Northing	Easting/Northing	Easting/Northing	none
Easting/Northing	Northing/Easting	Northing/Easting	yes
Northing/Easting	Easting/Northing	Northing/Easting	none
Northing/Easting	Northing/Easting	Easting/Northing	yes

All other coordinates are always displayed as selected in the "Coord. disp."

Editing various user parameters:



Activates the function "SET" in the dialog "User configuration".

CONF\ USER TEMPLATE		14:03
Password :	----	
User templ.:	Polar(Standard)	
Language :	ENGLISH	▼
REC Format :	GS18 (8 char)	▼
Distance :	Metre	▼ 3 Dec. ▼
Angle :	360° ' "	▼ 3 Dec. ▼
	RMASK	DMASK
	DEFLT	LIST

Temperature :	°C	▼
Atm. press.:	mbar	▼
Coord.disp.:	Easting/Northing	▼
Hz-system :	Clockwise (+)	▼
Face I :	V-drive left	▼



HELP



The following standard values are set:

Distance	=	metre, 3 decimal places
Angle	=	gon, 4 decimal places
Temperature	=	°C
Pressure	=	mbar (millibar)
Coordinate display	=	Easting/Northing
Hz-system	=	clockwise (+)
Telescope face I	=	V-drive to the left

The password and the language will be left the same.



Permits changing of default values with the following possible choice:

Password The current password is displayed in uncoded text. The password can be deleted using the key. A new password can be entered using alpha-numerical characters.

User templ. Individual name for the current user template.

Language Choice of the system language (as many as three languages can be stored at one time). English is always available and cannot be erased.

REC format

GSI8 8 characters
GSI16 16 characters

Distance

[units]

metre (m) metres
Int. ft international feet (ft), storage in US feet
In.ft/in int. feet, inches and 1/8 inches (0' 00 0/8fi), storage in US feet
US ft US feet (ft)
US ft/in US feet, inches and 1/8 inches (0' 00 0/8fi)
Inch Display in int. inches, storage in US feet
mm Storage in metres

[decimal places]

0, 1, 2, 3, 4 dec. 4 decimal places are only significant in connection with the electronic theodolites T1800, TM1800 with an attached DI2002 EDM or TC, TCM and TCA1800.

Angle

[units]

400 gon

360 ° ' "

360 ° decimal

6400 mil

[decimal places]

2, 3, 4 places

For the "gon" units, the models Txx1100 display the fourth decimal place only in steps of five. Angles displayed in "mil" units are displayed with 3 decimal places for all instruments

Temperature

[units]

° C

(degrees Celsius)

° F

(degrees Fahrenheit)

Atm. press

[units]

mbar

(millibar)

mm Hg

(millimetres mercury)

inch Hg

(inches mercury)

hPa

(hectopascal)

psi

(pounds per square inch)

Coord.displ.

Display method (order of appearance on display)

Northing / Easting (N, E)

Easting / Northing (E, N)

Hz-system

Direction

clockwise (+) (angles measured clockwise)

counter-cl.w. (-) (angles measured anticlockwise)

Face I

Definition

V-drive left (vertical drive on left side)

V-drive right (vertical drive on right side)

Functions of the fixed keys

Code information

Code blocks are used to record additional information for subsequent processing of the measurement data. They are recorded in separate blocks and consist of at least the CODE number, along with up to 7 further information blocks (Info 1 to 7). Each of these editable information words contains up to 8 (or 16) alphanumeric characters.

Information words which include "-----" are not stored. In general, the code function can be called whenever a measurement or another data set in the measurement file can be stored. The code function, together with the measuring mode, is available in most of the loadable applications.

 calls the standard coding (Code, Info 1 to 7), if no user-defined codes are present.

The user can use a Leica software package (code developer) on a PC to program personal "User codes". These "code-functions" can contain lists of codes or, for example, a complete process in which entries, recordings and displays are defined. On selecting a code it is possible to record it at once.

In order for the instrument to recognize and access these programmed code functions, they must be stored on a memory card under the "GSI" directory in the "CODE.HEX" file.



Activating the entry for the standard coding:

MEAS\		STANDARD CODE		14:03	
Enter Coding					
Code	:	-----			
Info 1	:	-----			
Info 2	:	-----			
Info 3	:	-----			
Info 4	:	-----			
REP C		REC			αNUM
Info 5	:				
Info 6	:				
Info 7	:				



HELP					
F1	F2	F3	F4	F5	F6



Calls the last code used and also the "Info" words.



When a new code is entered, or after using the key, "REC" is assigned to the key. Only information-bearing elements are recorded. Standard codes (Code, info 1 to 7) are recorded in separate blocks in GSI format behind the last measurement stored. These codes are not part of the recorded data block (recording template).

For details of how to use remarks to store additional information, refer to the chapter "Remarks".



Turns on the display- and reticle- illumination. Adjusts the:

- contrast of the display
- brightness of the display
- brightness of the reticle illumination
- Laser plummet ON/OFF
- brightness of EGL1 guide light (optional)
- Laser pointer, DISTO, DIOR.

The current values are shown in % numerically and also as a bar graph.

The current settings are only possible if the instrument has been additionally equipped.

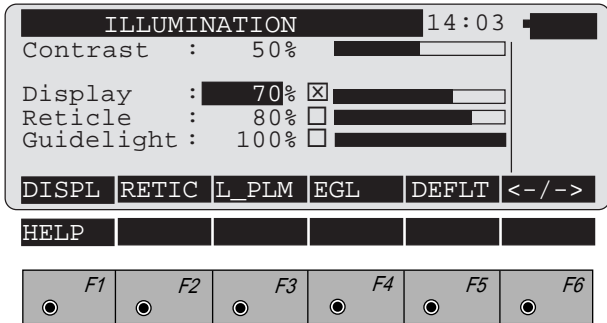

Turns the display illumination ON or OFF.



Turns the reticle illumination ON or OFF.



Turns the laser plummet ON or OFF. It switches off automatically after three minutes.



The assignment of the function keys depends on the equipment installed:

Turns the EGL1 guide light ON or OFF (EGL1),
key assignment "EGL"
or

Turns the laser pointer ON or OFF (for T-versions with an attached DISTO or DIOR),
key assignment "LASER"

or

Turns the eyepiece laser diode ON or OFF,
key assignment "DL".



Set default values.

(Contrast 50%, Display 70%, Reticle 80%)



Reduce value by 25%.



Reduce value by 5%.



Increase value by 5%.



Increase value by 25%.



At extremely low temperatures or with a very bright background illumination it may be necessary to readjust the contrast from its standard value of 50% to a higher value.

IO

Heatable display

If the TPS1000 is to be used at low temperatures, it can be equipped with a heatable display. This reduces the time which elapses before changes in the display are made evident, but does not expand the operating-temperature range for the instrument.

Note:

- The fact that the display is heatable is indicated by a label on the side of it
- The heatable display is available only for Face 1 (vertical circle, left)
- The heatable display requires an external battery
- The heating switches on automatically when the temperature sinks to -2°C and switches off again when it rises to $+1^{\circ}\text{C}$ or when the instrument is switched off
- Adjust the contrast of the display.

Electronic bubble



Graphical and numerical display of the longitudinal- and transverse tilts of the instrument's vertical axis.

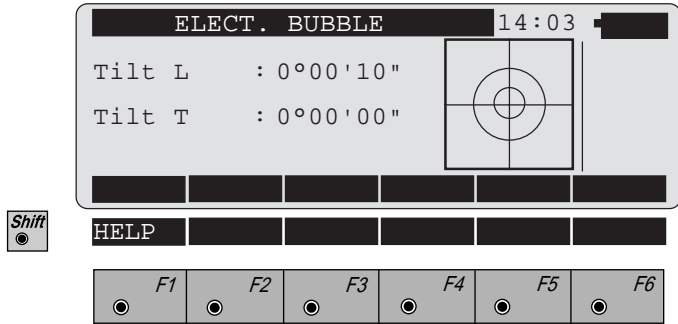

The instrument can be levelled-up using the foot screws, without having to turn it through 90° (100 gon) or 180° (200 gon).

In the display which is closest to the bull's-eye bubble, the movement of the small circle runs parallel to the movement of the bubble in the alidade. The other display shows the movement in the opposite direction.



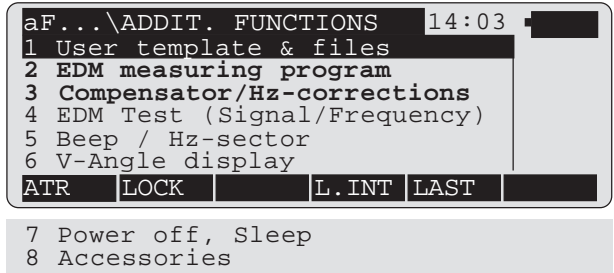

aF... - Additional functions

-  Various functions which can be called at any time. The changes become effective after the dialog has been quitted.

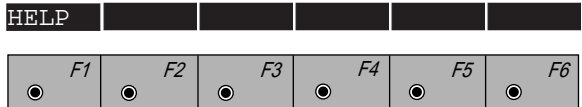

 Shift



-  **F1** Turns the ATR1 automatic target recognition ON/OFF, for locking on to static targets.
-  **F2** Turns the ATR1 automatic target recognition ON/OFF for following moving targets.
-  **F4** Interrupts the ATR1's LOCK mode for measuring longer distances, e.g. for targets beyond the range of the ATR1. When the distance measurement has been completed, then the ATR1's original position is immediately reset.
-  **F5** Turns the telescope to the last point stored.



The assignment of the function keys applies only to TCA instruments.

User configurations and files (1)

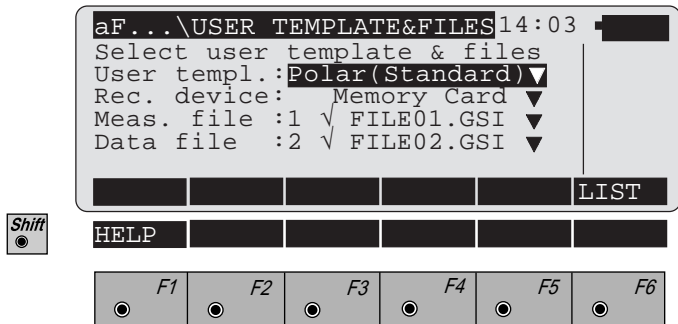



Choice of:

- user template
- data carrier
- measurement file for storing measurements
- data file for reading point coordinates.

EDM measuring program (2)

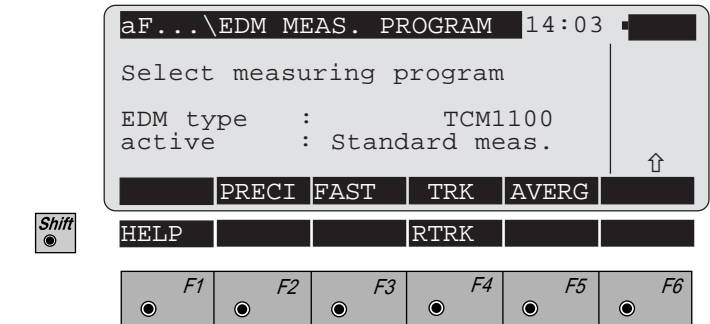
Select the EDM measuring program required.





 **F1** Standard measurement. Accuracy 2mm + 2ppm (Type 1800: 1mm + 2ppm). Time for a measurement: 3 sec. Normal distance measurement.

 **F2** Precision measurement.
Distance measurement with highest accuracy (1mm + 2ppm). Time for a measurement: 3 sec.
Only available for TCA1800 and DI2002.

 **F3** Fast measurement. Accuracy 3mm +2ppm. Time for a measurement: 1 sec.

 **F4** Tracking.
Continuous fast measurement. Accuracy 5mm +2ppm.
Time for a measurement: 0.3 sec.

 **F5** Average
Repeated measurement using normal mode, displaying the number of distance measurements, continuous average and the standard deviation of the averaged distance. Time for a measurement: 3 sec.

  **F4** Rapid tracking.
Continuous measurement. Accuracy 10mm +2ppm.
Time for a measurement: 0.15 sec.

Compensator / Hz-corrections (3)



Compensator

The working range of the two-axis compensator is 3' 47" (0.07 gon) for each of the axes.

Instr.setup

Only for the models 1700, 1800, 2003

No check

The tilt compensator is measured within its working range without any checks being made.

Stability check

The tilt compensator is specially checked and only allows recording when the compensator can measure the tilt to within the instrument-specific accuracy.

Compensator

ON



Turns on the compensator. The compensator measures the longitudinal- and transverse tilt of the standing axis. V-angles relate to the plumb line.

OFF

Turns off the compensator. The  icon is displayed in the status field. V-angles relate to the standing axis.

IO



	Hz-corr.	
	ON	Hz-corrections are turned on. The Hz-measurements are corrected for the following errors: <ol style="list-style-type: none"> 1. Hz-collimation error 2. V-collimation error (models 1700, 1800, 2003) 3. Standing-axis tilt, only when compensator ON
	OFF	Hz-corrections are turned off. The Hz-measurements are not corrected. The  - icon is displayed in the status field.



Example:

1. Compensator **ON**, Hz-correction **ON**
 V-angles relate to the plumb line. The Hz-measurements are corrected for the Hz- and V-collimation errors and the standing-axis error.
2. Compensator **ON**, Hz-correction **OFF**
 V-angles relate to the plumb line. No Hz-corrections are applied, on account of the influence of Hz- and V-collimation errors and the standing-axis tilt.
3. Compensator **OFF**, Hz-corrections **ON**
 V-angles relate to the standing-axis. The Hz-measurements are corrected for the Hz- and V-collimation errors.
4. Compensator **OFF**, Hz-corrections **OFF**
 V-angles relate to the standing axis. No Hz-corrections are made.

EDM test (4)

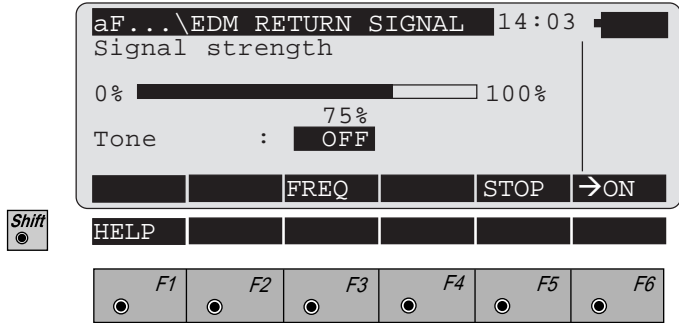
Displays the signal strength or measurement frequency.



-  **F3** Toggles between the displays of measurement frequency and signal strength. The measurement frequency display is similar to the display shown above.
-  **F5** End and return to the previous dialog.
-  **F6** ON/OFF - key for the acoustic tone. This key is only active when the signal strength is displayed.

The signal strength is indicated by a repetitive acoustic tone (beep), which is emitted more frequently when the signal is stronger. At signal strength 100% the acoustic signal is continuous.

Beep / Hz-Sector (5)

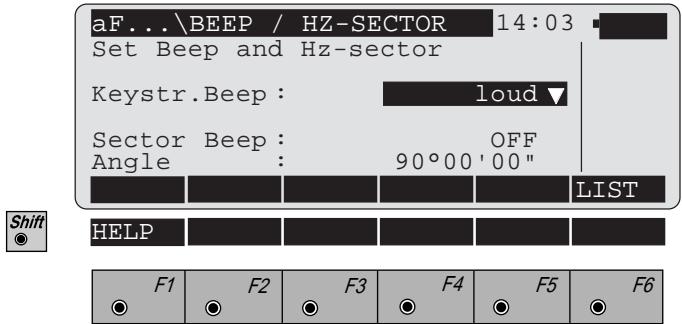

Keystroke beep

Sets the volume of the acoustic signal (beep) when the keyboard is operated. The beep is always active for messages.



no	Turns beep off
low	Beep quiet
loud	Beep loud

IO

Sector beep

Sets the beep ON/OFF for angle sectors.



ON	Turns beep on
OFF	Turns beep off

Angles

Here, angles are entered for which the beep should sound. When the angle is approached to within $4^{\circ} 30'$ (5 gon), a regular beep is heard. At $27'$ (0.5 gon) the beep is continuous. At $16''$ (0.005 gon) the beep ceases. Calculation of the angle always starts at $0^{\circ}00'00''$ (0.0000 gon).

V-angle display (6)

Sets the vertical-angle display.

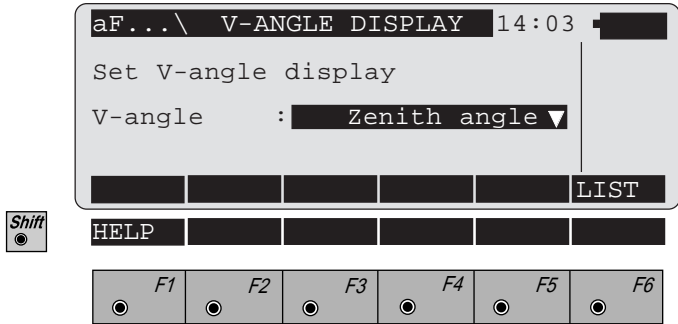

V-angle

Zenith angle

V = 0 at the zenith

Elev. angle +/-

V = 0 at the horizontal (elevation angles).
V-angles are positive above the horizontal plane and negative beneath the horizontal plane.

Elev. angle %

V = 0 at the horizontal.
V-angles are represented in % and are positive above the horizontal plane and negative beneath the horizontal plane.

Power off, Sleep (7)

Adjusts the automatic power-off criteria.

These are activated if no key has been pressed or no communication has passed over the interface within the given time period.

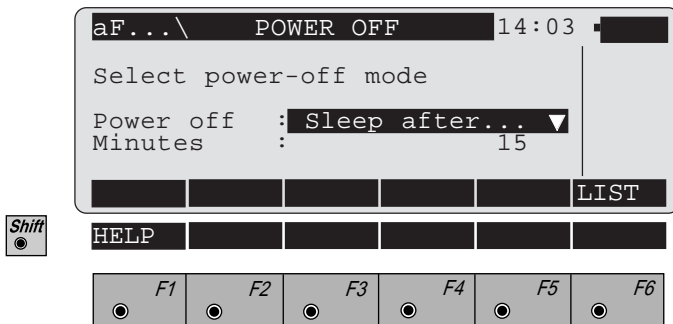

Power off

Sets the power-off criteria

Sleep after

If the time-out period has been reached, the instrument goes into a sleep-mode. In this mode, the power required is reduced by 60%. Current functions and applications can be resumed when the instrument comes out of sleep mode.

Auto OFF after

If the time-out period has been reached, the instrument will turn itself off.

Remains ON

The instrument remains on.

Minutes:



The time-out period in minutes which must elapse before the instrument goes into sleep-mode or turns itself off.

Accessories (8)

If an accessory such as the eyepiece prism or an additional lens for measuring to retro foils is used, then the movement for motorized instruments is restricted by preset values.

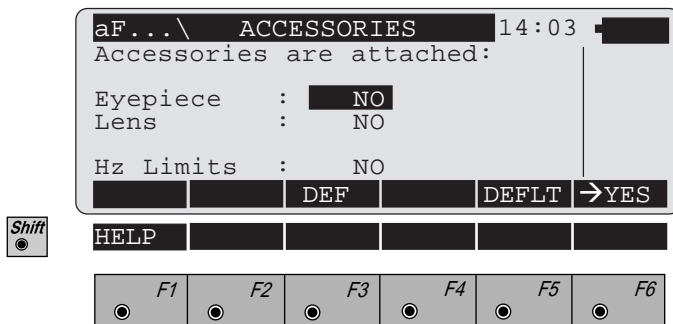
The horizontal movement can also be restricted, an advantage particularly for the remote-control mode.



-  **F3** Sets the limits of the movement
-  **F5** Returns all settings to **NO**.
-  **F6** For changing one of the settings.

A starting value and a finishing value are displayed. These determine the limits of movement of the telescope for motorized instruments. The range of movement between the starting value and the finishing value is defined by one clockwise rotation. The limits are entered for the vertical angle for the objective side (lens) and for the eyepiece side, and for the horizontal directions. The altered values are retained when the instrument is switched off.

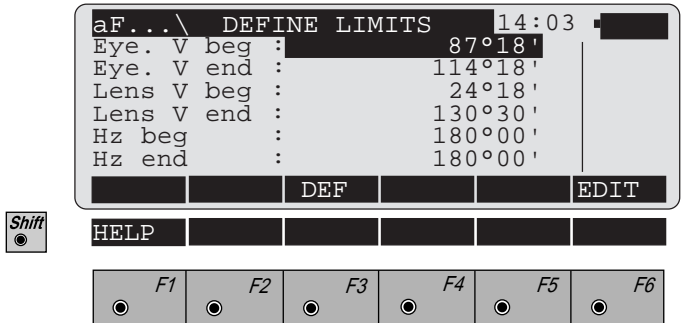

Values can be directly entered with the keyboard, or they can be determined through the position of the telescope.



F3 Moves the telescope to the position of the appropriate limiting value. The value displayed changes during the movement.



F4 Accepts the value displayed as being the limit of movement.

Eye. V beg Starting value for V-angle of eyepiece.

Eye. V end Finishing value for V-angle of eyepiece.

Lens V beg	Starting value for V-angle of objective.
Lens V end	Finishing value for V-angle of objective.
Hz beg	Starting value for Hz-direction.
Hz end	Finishing value for Hz-direction.



If the Hz-direction of the instrument is outside the permitted range but the target is within the permissible range (range of movement) the instrument may turn to the target.

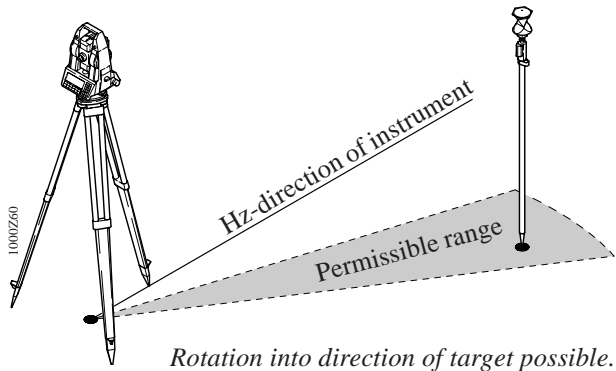

In the reverse case rotation is not possible and an error message is displayed.

ON/OFF



Turns on the instrument and the start-up display is shown.

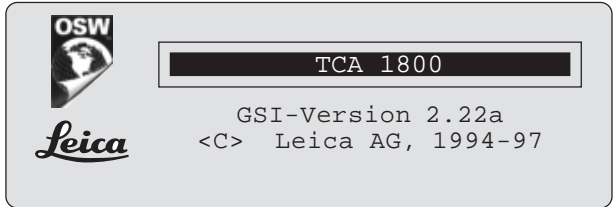

This display shows the instrument type and the software version for about 2 seconds. Afterwards, the main menu is shown or the chosen start-up application is activated.



Shows the following display when instrument is switched on:

IO

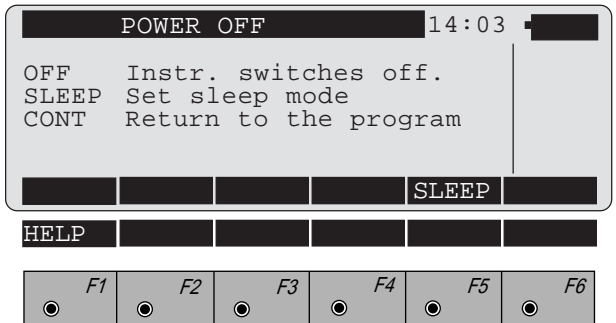

Enter sleep-mode. The power consumption is reduced by about 60%.
With any key you can return to the last active dialog.



Back to the last active dialog.



Turns the instrument off.



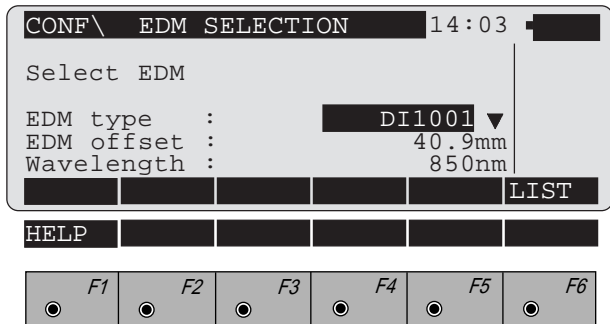

Activate the function from the "SYSTEM CONFIG" dialog.

The option "Select EDM" is available only for model T and model TM instruments.



Choose from the EDM list.

Using the  and -keys, choose the relevant EDM:
(DI3002 = DIOR3002 and DI3002S = DIOR 3002S)



Confirm the choice.

The EDM offset and the wavelength are automatically set. The correction of the distance measurement on the basis of the EDM offset correction can be switched on and off in accordance with *the chapter "Set and define prisms"*. This correction is only necessary for prisms which are permanently in the vertical position.

Automatic Target Recognition

TCA instruments are motorized and equipped with Automatic Target Recognition (ATR1) coaxially in the telescope. The EGL1 guide light, mounted on the telescope, is optional.

These instruments permit automatic angle and distance measurements to normal prisms and reduce the tedium of precise visual sighting to prisms.

The prism is sighted with the optical sight only.

Initiating a distance measurement will turn the instrument with the help of the motors to sight the prism-centre automatically.

The angles V and Hz are measured to the centre of the prism at the completion of the distance measurement.



As with all other instrument errors, the collimation error of the automatic target recognition (ATR1) must be redetermined periodically (*Refer to chapter "Checking and Adjusting"*).

AR

The built-in Automatic Target Recognition ATR1 transmits a laser beam. The reflected light is received by the built-in camera (CCD). The position of the received light spot with respect to the centre of the CCD is computed and the offsets are used to correct the horizontal and vertical angles. The offsets are also used to control the motors which turn the instrument so that the crosshairs are centred on the prism.

In order to minimize the times for measuring, the crosshair is not moved to the exact centre of the prism. The offset can be up to 5mm.

Then the Automatic Target Recognition ATR1 measures the offsets between the crosshair and prism centre and corrects the Hz and V angles accordingly.

Therefore the Hz and V angles are measured to the prism-centre, regardless of the crosshair pointing precisely to the centre of the prism.



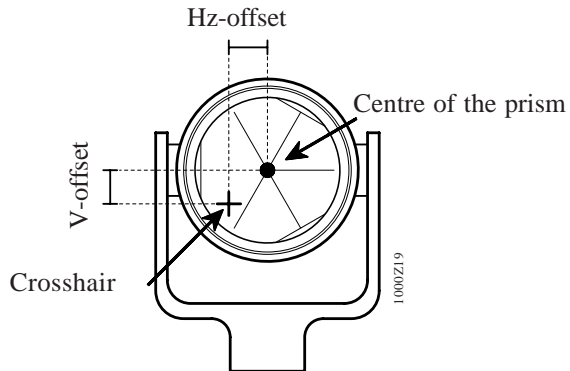

If the offset is more than 5mm when the prism is exactly aligned and in faultless condition, the Automatic Target Recognition ATR1 must be recalibrated. If excessive offsets occur frequently, contact your Leica agency.

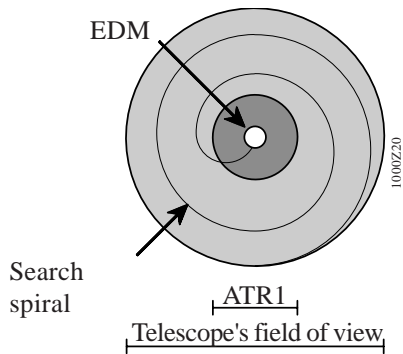

The sensitive area of the ATR1 is the central third of the telescope's field of view. The ATR1 recognizes the prism instantly if the latter is within this sensitive area. Otherwise the telescope's field of view is scanned spirally until the prism is located. The spiral search of the field of view of the telescope, and the recognition of the prism, together take about 2 - 4 seconds.



Operation

For TCA instruments the parameters for Automatic Target Recognition ATR1 are assigned to the function keys , ,  and  under the fixed key .

ATR1 mode

This mode permits measurements to static targets.

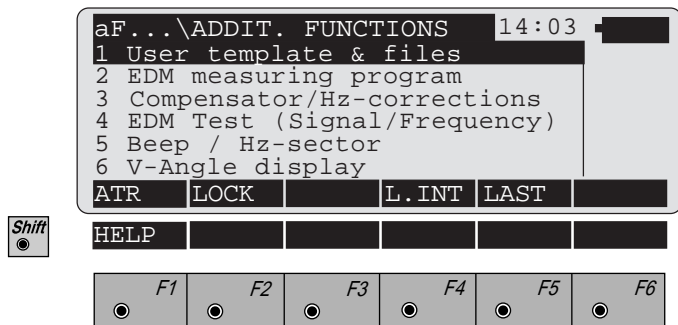

AR



Switches the automatic target recognition **ON** for the ATR1-mode.

The display returns immediately to the previous dialog. Calling the aF... - dialog again and pressing  will switch the ATR1-mode **OFF** once more .

The operator must sight the prism coarsely using the optical sight, so that the prism is within the field of view.

Activating a distance measurement moves the crosshair close to the centre of the prism with the help of the motors, to permit a distance measurement.

If the prism is outside the sensitive area of the ATR1, the telescope's field of view is scanned using a spiral movement to search for the prism. Thereafter the distance is measured.

The icon  is shown in the lower left area of the status field whenever the **ATR1** mode is active.

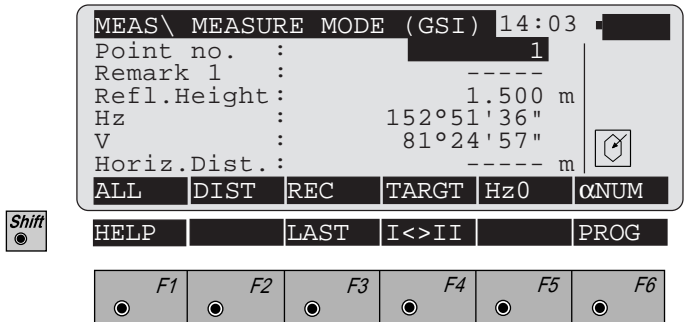

The error message 565 appears if no reflector is found after the search routine:

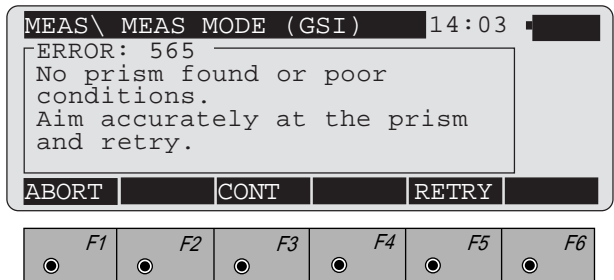

F1 Abort the measurement and return to the measure mode dialog.



F3 Continue with a new distance measurement, without first re-targeting with the ATR1. This function can be used if the prism has been located but the required accuracy has not been attained. This situation could arise under poor environmental conditions or from a combination of short measuring distance and unstable prism.



F5 Repeat the search routine. The scanning area will be increased by 1/3. At each repetition the last search area is increased by 1/3. The centre of the crosshair returns to the initial point after each search routine if no prism is found.

LOCK-Mode

Lock-mode will enable TCA instruments to follow a moving prism. Distances can be measured whenever the prism stops for a short time (Stop and Go mode).

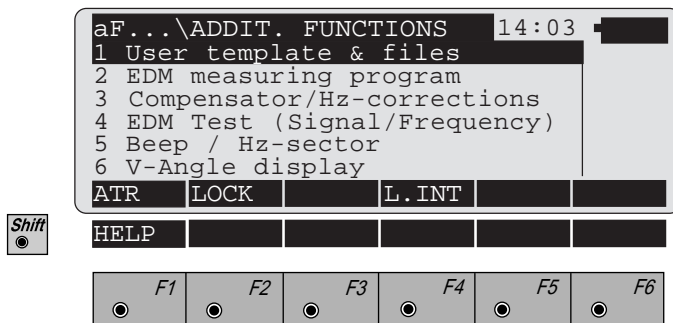

Switches the automatic target recognition **ON** for the LOCK-mode.

The display returns immediately to the previous dialog.

Calling the **aF...** dialog again and pressing  will switch the LOCK-mode **OFF** once more.

The icon  is shown in the lower left area of the status field when the LOCK-mode is activated and before a prism is found.

Switching to LOCK mode requires an initial distance measurement so that ATR1 "learns" the prism.

The first measurement is identical to that carried out in ATR1 mode.

If the prism is subsequently moved, the telescope tracks it automatically for as long as the prism is aligned to the instrument.

The displayed angles refer to the crosshair direction during search. Once the prism is static, a distance measurement can be activated using "DIST" or "ALL". In this case the angles are measured on the centre of the prism after the distance measurement.

After a distance measurement, these corrected angles (for the centre of the prism) are displayed or recorded.

The icon  is shown in the lower left area of the status field if the **LOCK** mode is active and if the telescope tracks the prism.

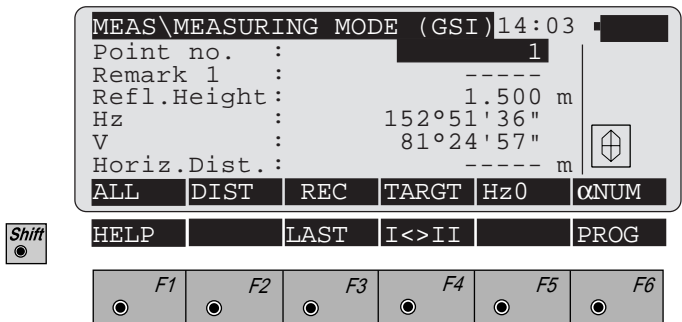

Any interruption to the tracking of the prism is indicated for about two seconds graphically in the lower left status field by the symbol  and also by a continuous acoustic signal (beep).



If the measuring assistant changes position too fast, there is the possibility of the ATR1 automatic target recognition losing lock.

Make sure that the speed of target movement does not exceed the specifications. (*Refer to chapter "Technical specifications"*).

L.INT-Mode

The LOCK mode is interrupted until the next distance measurement (LOCK interrupt).

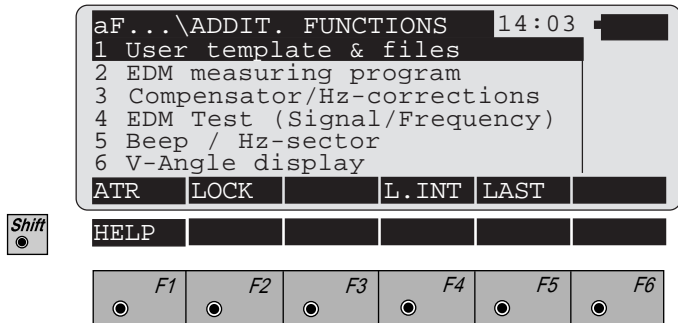

Interrupts the ATR 1 until the next distance measurement.

The last mode of the ATR 1 is reactivated once the distance is successfully measured.

AR

This function should be used for measuring to a second prism (Changing the prism).

The icon  is shown in the lower left area of the status field, once the **L.INT**-mode is activated. Measured angles refer to the direction of the crosshair.

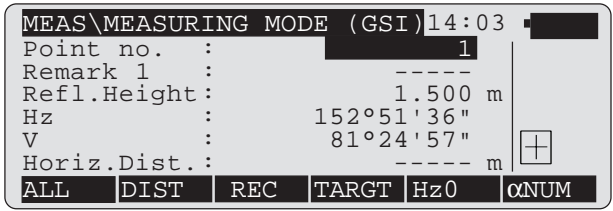

HELP LAST I<>II PROG

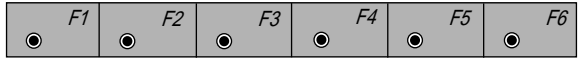

At the completion of the distance measurement, the LOCK mode is reactivated and the corresponding icon shown in the lower left area of the status field.

Previous point



Aligns the telescope to the last point which was stored.

***Automatic Target
Recognition ATR1
resolution modes***

The accuracy with which the position of a prism can be determined with Automatic Target Recognition ATR1 is dependent on the internal accuracy of the ATR1 itself, and on the external accuracy, which is affected in particular by the type of prism and by the ambient brightness. The external accuracy is attained if the measurement is repeated at intervals.

The internal accuracy of the ATR1 depends on the resolution of the CCD camera, on the time for the measurement, on the condition and position of the prism, and on other factors; it is the accuracy obtainable under optimum conditions at one particular time.

Generally, the accuracy of the ATR and of the angle measurement are the same. Under a certain distance, however, ATR accuracy predominates. That distance is determined by the angle accuracy of the instrument.

The external accuracy of a prism-position determination is important to the user and is ± 2 mm in the standard EDM measuring mode for Leica circular prisms or ± 1 mm in the precision EDM measuring mode. For the 360° reflector it is ± 5 mm each for the transverse and vertical component.

ATR1 and angle-measurement accuracy (acc. to DIN 18723)

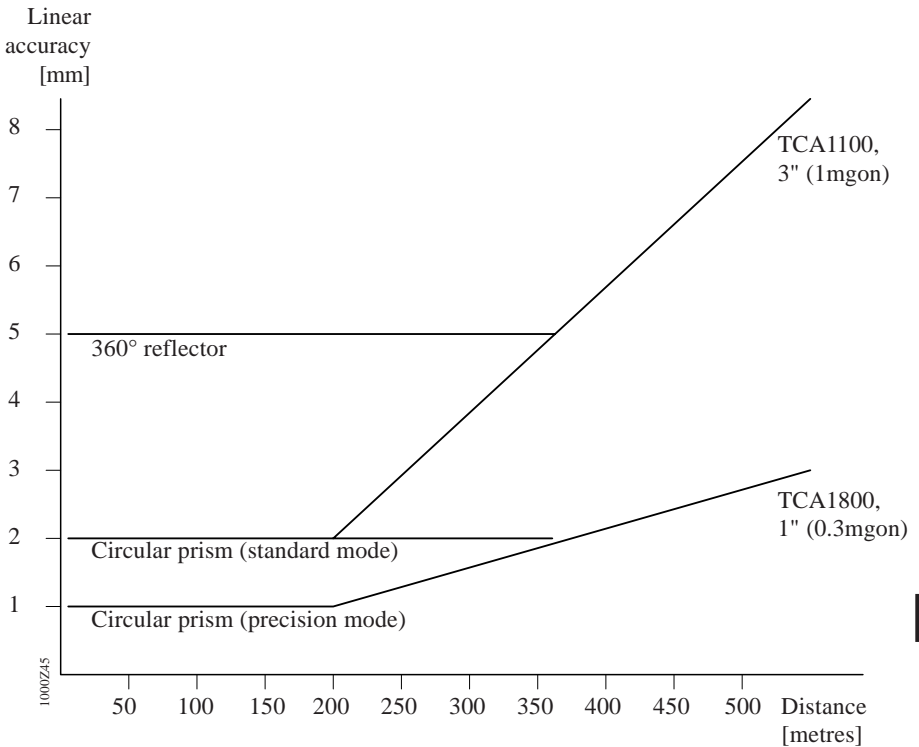

AR

The diagram shows the effect of distance on the linear accuracy of the prism position and on the angle measurement, for a TCA1800 (1") and for a TCA1100 (3").

An example based on the diagram

Up to 200m the angle measurement accuracy of 1" corresponds to a deviation of about 1mm. It is evident that the specified accuracy of the angle measurement is not maintained with the Automatic Target Recognition, particularly at short ranges.

TC2003/TCA2003
ATR1-* and angle-measurement accuracy
(acc. to DIN 18723)

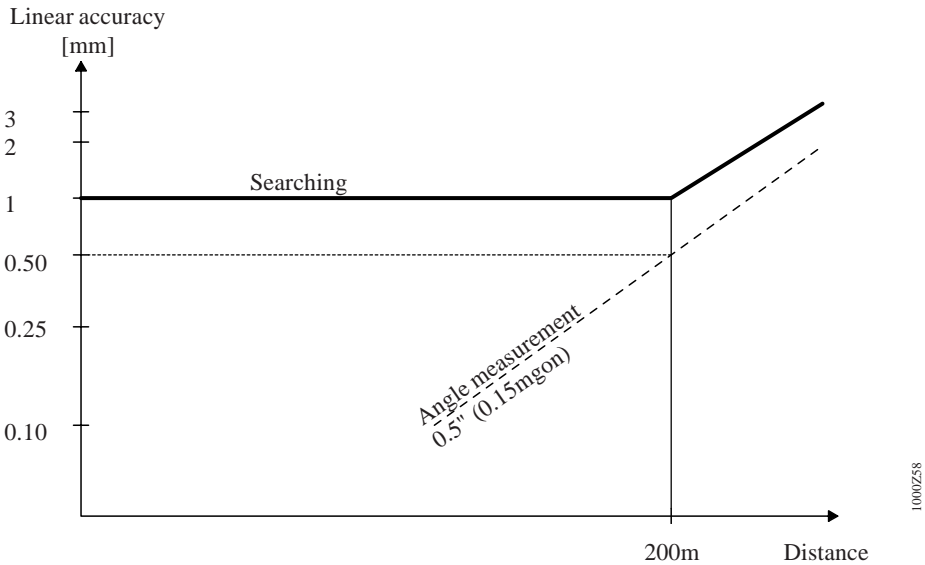

AR

* Under good atmospheric conditions in the precision mode.

Increasing the accuracy

If the external conditions remain constant, then for short-range work the accuracy of the Automatic Target Recognition ATR1 can be improved so that it borders on the accuracy limits for directional measurements.

The required conditions are:

- Leica circular prism exactly positioned
- Prism clean and not fogged
- Constant light conditions, background dark
- No atmospheric disturbances, including refraction.

Stability of the prism setup

The demands made on the stability of the prism when measuring several sets of angles for monitoring a dam are different from the demands in connection with a topographic survey. In the first case, better accuracies are expected.

In accordance with the distance-measuring program selected, a tolerance range is defined within which the prism may apparently or actually move.

Tolerance range for prism stability

Mode	Key	ATR 1
Standard	(STAND)	2 mm
Precise	(PRECI)	1 mm
Fast	(FAST)	3 mm
Tracking	(TRK)	3 mm
Average	(AVERG)	2 mm
Rapid Tracking	(RTRK)	3 mm

AR

In the first stage, the Automatic Target Recognition ATR1 investigates the stability of the prism. If this is acceptable, the angle corrections are then determined. The accuracy of the **measurement** is always the same, irrespective of the setting chosen.

***Information on the use
of Automatic Target
Recognition ATR1***

General

The range of automatic target recognition can be restricted, and its functioning impaired, by various external factors.

There follows here a description of the causes, of the resulting error reports, and of possible counter-measures.

The accuracy for the target point recognition of the TCA is determined by the selection of the EDM measuring mode. The highest accuracy for the target point recognition by the ATR is obtained in the precision mode (PREC1).

The setting PRECI must be selected for the TCA2003 in order to reach the specified angle measurement accuracy of 0.5" (0.15 mgon) during target recognition measurements.

During measurements in this mode it is possible that the measuring period is prolonged up to about one second.

Reduction of the range

Reduction of the range under the following unfavourable atmospheric conditions:

- Hot sunny weather
- Strong heat shimmer
- Bright reflections of the sun in the field of view.
Such "hot-spots" can also be produced outside the focusing range by vehicles and other shiny objects.

Counter-measures:

- Reduce the measurement distance
- Cover bright reflections
- Measure without Automatic Target Recognition ATR1, i.e., after the error report "No prism found ...", target manually and trigger distance measurement with .



Atmospheric conditions influence the range of the ATR1 more than that of the EDM, and so the range data for the ATR1 are only approximate.

AR

Disturbance in ATR1 mode or at start of LOCK mode

(The ATR1 is unable to recognize the prism)

This may be due to various causes and may provoke various error reports:

- **"No prism found or bad conditions. Aim accurately at the prism and retry."**

Causes:

- No prism in field of view of telescope
- Strong heat shimmer
- Measurement distance too great
- Environment too bright (sunshine on bright surfaces, e.g. snow)
- Bright reflections of sun in field of view, close to prism.

In the two last instances, the report "Interfering reflection" may also appear.

Counter-measures:

- Reduce measurement distance
- Cover reflections
- Measure without Automatic Target Recognition ATR1

- **"Multiple prism found ! Aim more accurately at the prism."**

Causes:

- Several prisms in field of view
- Raindrops on prism or on object lens of telescope

Counter-measures:

- Ensure that only one prism is in field of view
- Remove raindrops



Raindrops, condensation or dirt on the prism may result in the quoted accuracy not being reached with the automatic target recognition, because the target point of the ATR1 will be displaced as a result.

- **"Position not achieved. Time out of positioning system, prism unstable, air shimmer or other error. Try again."**

(The ATR1 cannot attain the positioning precision required)

Cause:

- Oscillation of the reflector pole at short distances

Counter-measures:

- Hold reflector pole still or support it.
- Measure without Automatic Target Recognition ATR1
- Select a different DISTANCE-MEASURING PROGRAM.

AR

Disturbance of target tracking in LOCK mode

Causes:

- Measurement distance too great
- Bright reflection close to prism (instrument tracks reflection)
- Highly-fluctuating ambient brightness or strong heat shimmer (instrument trembles or turns away from prism)

Counter-measures:

- Reduce measurement distance
- Target prism manually and restart LOCK

Instrument suddenly switches off

The instrument can switch off without warning, even though the battery display still shows "1/3 full".

Cause:

- There are very high current-consumption peaks when the motors are starting up and when the EDM is being switched on.

Counter-measures:

- Change the battery

Range under average atmospheric conditions (reference values)

Reflector used	Range [metres]
Circular prism	1000
360° reflector	500

RCS (Remote Controlled Surveying)

Introduction

This option enables TCA models to be remote-controlled from the region of the prism. Combined operation, partly at the TPS1000 and partly at the prism, is also possible.

As a result, surveys can be performed solo. It is also possible to monitor the operation on the RCS 1000 and / or to enter the coding on the RCS 1000.

All functions of the TPS1000, including the applications programs, are available on the RCS 1000. The display and the use of the keys are as for the TPS1000. In addition, the characters can be entered directly on the RCS 1000.

For the RCS you require an RCS 1000, two radio modems and the appropriate cables.

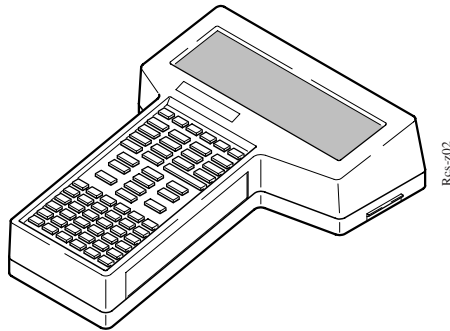

RCS 1000

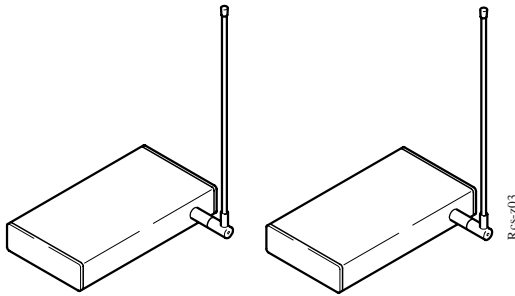

TCPS25

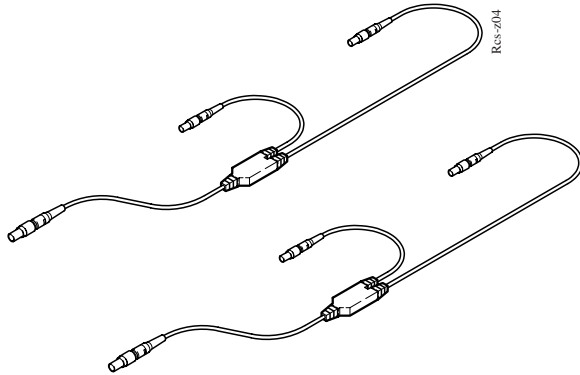

Cables

Control units and radio modems from other manufacturers can also be used under certain conditions. Please consult your Leica agency.



WARNING :

Adverse use can lead to injury, malfunction, and damage.

It is the task of the person responsible for the instrument to inform the user about hazards and how to counteract them. The RCS 1000 are not to be used until the user has been properly instructed how to use them.

For safe use of the RCS 1000, pay attention to the important safety regulations in the "RCS 1000" user manual (*refer to chapter "Safety directions"*).



This chapter describes how to put the standard TCPS25 radio modems into operation. If you use other radio modems the description and pictures may differ.

Step 1: Set up the TPS1000 and level it as described in *section "Set up"*.

Step 2: Attach to the tripod:

- one radio modem (by means of the enclosed shackle)
- an external battery (GEB70 or GEB71).

Using the appropriate cables, connect one radio modem to the TPS1000 and the other to the RCS 1000. Check the colours of the plugs (white at the radio modem).



The radio modem can be fastened with "Velcro" to the remote pole bracket to ensure it remains in position.

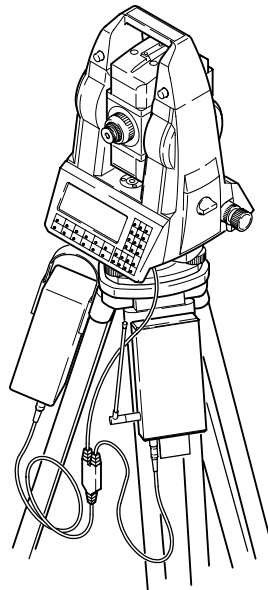

Res-705



Step 3: Switch on the TPS1000 and carry out the following setting operations under "CONF / GSI communication param.":

Baud rate	4800 (ev. 9600)
Protocol	GSI
Parity	None
Endmark	CR LF
Data bit	8

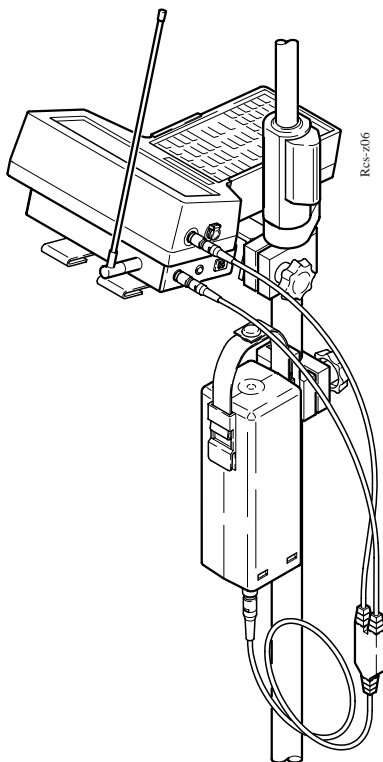
Step 4: Secure the RCS 1000 holder to the reflector pole. Push the RCS 1000, the second radio modem and an external battery into the holder and connect with the right cables.
Use COM 2 at the RCS 1000 (no cover).
Check the colours of the plugs (white at the radio modem).



Step 5: Select remote-control mode from main menu of TPS1000:

 (EXTRA) /  (remote-control mode) /  (YES)

Step 6: Switch on the RCS 1000 and start the program by pressing . Check the communication parameters as described in chapter "RCS1000". Now, the RCS 1000 is ready to receive data from the TPS1000.

The TPS1000 is now ready. It receives all orders from the RCS 1000 and sends the contents of the display to the RCS 1000. The data are recorded on the PCMCIA card of the TPS1000, as in the normal operation mode. No provision is made for using the RS232 interface for storing data on the RCS 1000.



The keys shown in this chapter correspond with the keys of the RCS 1000. Only at "step 5" the keys of the TPS 1000 are depicted.

Allocation of keys

The allocation of the keys on the RCS 1000 is the same as on the TPS1000. When the RCS is switched on, the TPS1000 automatically changes to LOCK mode (prism tracking). In the status field on the TPS1000 display there appears the symbol  which signifies the RCS mode. The function keys under **aF...** are reassigned.

The functions serve to target the TPS1000 on the prism. The search field for the prism is increased to 18° (20 gon).

The target functions are required :

- to achieve the first LOCK
- for LOCK replacement in the event of LOCK loss (through longer interruptions to viewing).

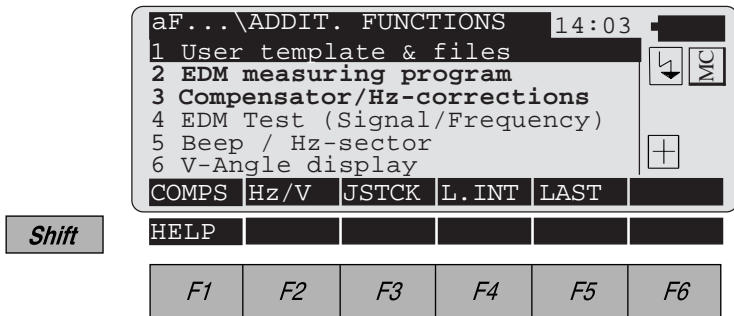

F1

Sets the TPS1000 to compass mode, enabling the TPS1000 to be targeted on the prism with the help of a compass.

F2

By entering relative or absolute angle values, the TPS1000 can be turned by the corresponding amount or set to the angle value required.

F3

In the joystick mode, the TPS1000 can be turned horizontally or vertically with the aid of the cursor keys.

F4

Causes a LOCK interruption.

F5

Turns the TPS1000 to the last point stored.

Working procedure

Working in RCS mode is hardly different from working in the normal measuring mode. A switchover is possible on the TPS1000 at any time.

The great advantages of the RCS are:

- solo operation is possible
- when surveying you are at the site of the action, i.e. where the points are being recorded or set out
- you do not have to assess the situation from the instrument location.



It is essential to cordon-off and protect the measurement location. The actions and effects of personnel, machines and the weather can damage the instruments.

After the TPS1000 has been set up and the RCS mode activated, the TPS1000 must be approximately lined up with the reflector in order that a LOCK operation can be carried out on the reflector. After the TPS1000 has locked on to the reflector, it follows all movements of the reflector and is set centrally to it. It is therefore advisable to work with the 360° reflector (GRZ4), since this does not require special prism settings.

RC

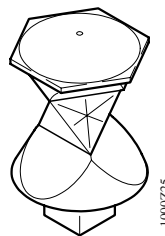

360° reflector (GRZ4)

This lining-up can be performed manually from the TPS1000 or from the reflector.



Using the EGL1 guide light makes lining-up a lot easier. The EGL1 guide light is a flashing light which can be installed into telescopes of the TC, TCM and TCA instruments (optional).

If you are in the measurement display screen, then the search process can be started at any time. As in normal operation, this happens when you initiate a distance measurement ("**DIST**" or "**ALL**"). The TPS1000 now locks on to the reflector. The search window in RCS mode is 18° (20gon).

Starting from the RCS 1000, an approximate alignment of the TPS1000 on the reflector can take place with the functions available under **aF..**. The search process can then be started with **CONT**.

These functions will be later described in more detail.

Compass

aF..

F1

Activates the compass mode.

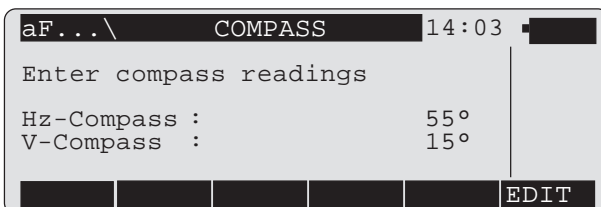

Shift

HELP

F1 F2 F3 F4 F5 F6

In order to use the compass mode we recommend you to use a hand-held compass with 360° rotatable Hz circle and incorporated V circle, e.g. RECTA DP6 or SILVA Ranger 15 / 25.

Compass mode is suitable for aligning the TPS1000 over longer distances. To establish the link between TPS1000 and compass, proceed as follows:

- Step 1:** Perform the Hz orientation on the TPS1000.
- Step 2:** Turn the TPS1000 until Hz shows 0.000 (irrespective of the angle units being used).
- Step 3:** Look into the telescope of the TPS1000 and select a prominent target.
- Step 4:** Aim the compass at the same prominent target and turn the Hz circle of the compass until the compass needle is at 0° or at N (north). Do not turn the Hz circle again.

From the prism, aim the compass towards the TPS1000:

- to lock the prism for the first time
- or if you lose the LOCK setting.

RC

Read off from the compass:

- the Hz angle indicated by the compass needle (0° to 360°)
- the V angle (+90° to -90°, horizontal = 0°) and enter these values in the RCS 1000.

CONT

Quits the compass mode and starts the search mode.

ESC

Quits the compass mode or breaks off the search mode.

Hz / V

aF...

F2

Activates the Hz / V mode.

aF... \	Hz / V	14:03	
Set relative Hz- and V-angles			
Hz / ΔHz	:	0°00'00"	
V / ΔV	:	0°00'00"	
		ABS	EDIT

Shift

HELP

F1

F2

F3

F4

F5

F6

In Hz/V mode, the TPS1000 can be turned by preset angle values.

The input options are:

- absolute angle values which relate to the orientation of the TPS1000
- relative angle values which cause the TPS1000 to turn away from its present position by the amount entered.

F5

Switches between absolute (ABS) and relative (REL).

CONT

Quits the Hz/V mode and starts the search mode.

ESC







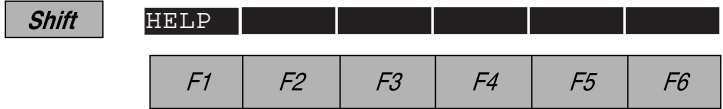
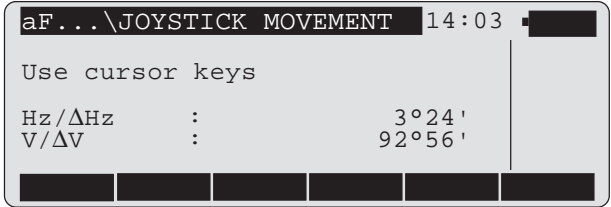



Quits the Hz/V mode.

Joystick

aF... **F3** Activates the joystick mode.



In the joystick mode, the cursor keys on the RCS 1000 can be used to turn the TPS1000. The EGL1 guide light, if available, is switched on automatically.

-  Turns telescope slowly to the right ( left)
-   Turns telescope rapidly to the right ( left)
-  Turns telescope slowly upwards ( downwards)
-   Turns telescope rapidly upwards ( downwards)

To stop the rotary movement, press any cursor key.

CONT Quits joystick mode and starts search mode

ESC Quits joystick mode or breaks off the search

Lock interruption

aF...

F4

Activates the lock interruption.

This function serves to interrupt the LOCK mode and later to reinstate it, e.g. before the prism is placed on the ground during setting-out or if the TPS1000 is also to be targeted on a second prism.

Last point stored

aF...

F5

Activates the LAST function.

If the LOCK mode is lost, this function can be used to turn the TPS1000 back to the last point stored. When the movement is complete, the TPS1000 automatically starts to search for the prism.

RC

ESC

Stops search mode.

Guide Light EGL1

The optionally available Guide Light EGL1 consists of two coloured blinking lights in the telescope of the total station. All TPS1000- instruments can be equipped with this Guide Light. The person at the prism can be guided by the blinking lights directly to the line of sight. The lights can be sighted up to 150 m away from the instrument. Stake out will be much easier with EGL1.

ON / OFF

The screenshot shows the instrument's menu system. The main display area is titled 'ILLUMINATION' and shows the time '14:03'. Below the title, there are three settings with progress bars: 'Contrast : 50%', 'Display : 70%' (with a checked box), and 'Reticle : 80%'. Below these is 'Guidelight : 100%'. A menu bar at the bottom of the screen shows 'DISPL', 'RETIC', 'L_PLM', 'EGL', 'DEFLT', and '<- / ->'. Below the menu bar is a 'Shift' key and a 'HELP' key. At the bottom of the screen are six function keys labeled 'F1' through 'F6', each with a small circular indicator.

EG



F4 Turns the EGL1 guide light ON or OFF. To achieve best performance, when using the Guide Light, the intensity should be adjusted for different light conditions (adjustable in three steps).



Menu option only active with installed EGL1.

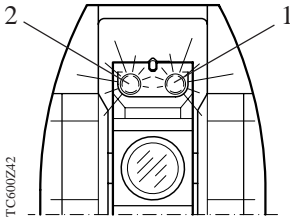

- 1 Blinking red LED
- 2 Blinking yellow LED

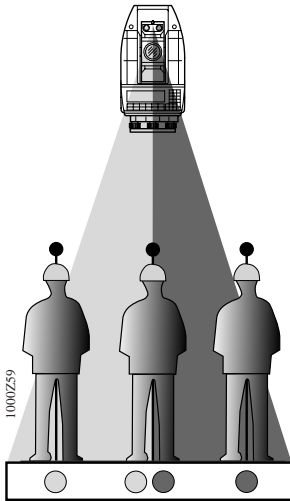

At a target distance of 100 meter (330 ft) a red/yellow blinking cone of light at both sides with a width of 6m (20 ft) each is formed. As a result, guiding to the line of sight of the instrument is much easier and faster.

Between both cones of light an about 30 mm wide sector is created. Within this sector both colours are blinking simultaneously. In this case the prism is already right in the line of sight.

Operating range: 5 - 150 m (15 -500 ft)
 Divergence: 12 m (40ft) at 100m (330 ft)

EG

Checking and adjusting

Electronically

In general, the instrument possesses the following mechanical errors:

- (l, t) Index error from the 2-axis compensator
- (i) Index error from the vertical encoding circle
- (c) Line-of-sight error
- (a) Tilting-axis error
- (ATR) Collimation of the target recognition axis (TCA versions only)

The above instrument errors can change over time and with temperature.

They should, therefore, be redetermined in the order shown below:

- before the first use
- before each precision survey
- after long periods of transport
- after long periods of work
- if the temperature alters by more than 20°C

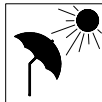

Before determining the instrument errors, level-up the instrument using the electronic bubble. The instrument should be secure and firm, and should be protected from direct sunlight in order to avoid thermal warming on one side only.



The determination of the instrument errors can be started in any telescope face.

Activate the function  in the main menu.

CA

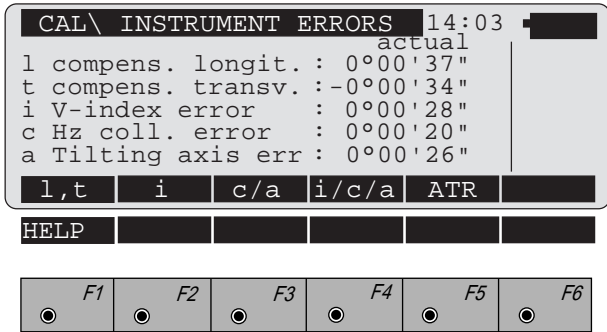

Determine the compensator index error.
Simultaneous adjustment of the electronic bubble.



Determine the index error for the vertical circle
(V-index error) *



Defining of line-of-sight errors and, if required, of
tilting-axis errors *



Joint determination of the V-index errors, line-of-sight
errors and, if required, tilting-axis errors.



Determine the collimation error of the ATR1
(TCA versions only).

* depending on the setting within the "Functionality".

The option to determine the tilting-axis error does not exist for the series 1100 instruments.

The instrument errors reported are displayed in the sense of an error. When correcting measurements, they are used in the sense of corrections and have the opposite sign to the error.



Check your equipment after long storage or shipment before using it again. If necessary, determine instrument errors again.

Compensator (electronic bubble)

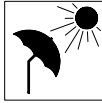

The determination of the index error for the longitudinal and transverse axes of the compensator (l, t) corresponds to the determination of the centre of the bubble used in the level.

The instrument should be set up away from warmth coming from one side some time before the calibration so that it can adjust to the ambient temperature.

The index error for the longitudinal and transverse axes is determined at the factory and adjusted to zero before delivery.

Vertical axis Compensator axis

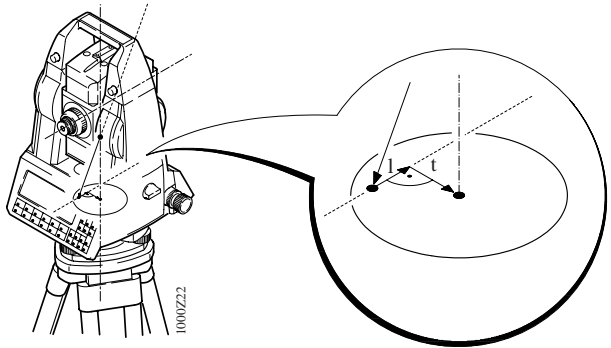

Activate the calibration procedure. (Refer to display on page 176)

The longitudinal and transverse axes (l, t) are displayed afterwards in the following dialog.

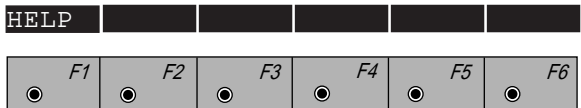
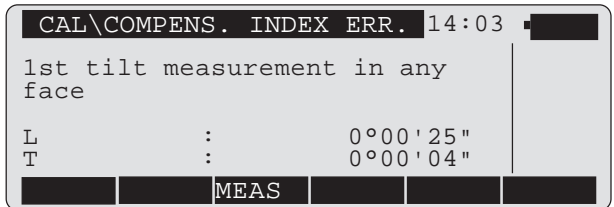

Initiate the measurement of the longitudinal and transverse tilt (l, t).

CA

If the tilt cannot be measured, e.g. due to an unstable instrument, the error message ERROR: 557 is displayed and the following keys are defined:

 **F1** Abort measurement.

 **F5** Repeat measurement.

Non-motorized instruments perform the second measurement after the alidade of the instrument has been turned 180° (200 gon), with an accuracy of ±4° 30' (±5 gon).

After the initial measurement has been started by pressing the key , motorized instruments will automatically complete the determination of I and t without any other assistance.

The following dialog is displayed after completing the first tilt measurement with non-motorized instruments.







TELESCOPE POSITION 14:03 I

Hz- and V-positioning:
Set direction(s) to zero.

ΔHz : 180°00'00"
ΔV : -----

ABORT

 **HELP**

 **F1**
 **F2**
 **F3**
 **F4**
 **F5**
 **F6**

Turn the instrument again 180° (200 gon) so that Δ Hz = 0° 00' 00" (0.0000 gon). Then "OK" appears on

 .







TELESCOPE POSITION 14:03 II

Hz- and V-positioning:
Set direction(s) to zero.

ΔHz : 0°00'00"
ΔV : -----

ABORT OK

 **HELP**

 **F1**
 **F2**
 **F3**
 **F4**
 **F5**
 **F6**







If the differences between the horizontal and vertical angles lie within $\pm 4^{\circ} 30'$ (± 5 gon), the display can be quitted with .

The user is made aware by an acoustic signal that the -key is redefined as "OK".

 **F5** Activates the second tilt measurement.

 **F1** Terminates the determination of the compensator indexes.

The following dialog shows the two newly-determined values for the longitudinal and transverse compensator-index errors.

CAL\COMPENS. INDEX ERR.		14:03			
		new			
l Comp.	:	0°09'02"			
t Comp.	:	0°08'06"	II		
Accept new value(s)?					
RETRY		NO	YES		
	HELP				
					

 **F1** Repeats the complete calibration procedure.

 **F3** Leaves the previous values unchanged.

 **F5** Stores the new values.



If the values for the index errors (**l**, **t**) exceed 5' 24" (0.1 gon), the complete calibration procedure should be repeated, but not before checking that the instrument is correctly levelled and is free of vibration. If these values are exceeded repeatedly, please notify service.

V-index error

The V-index error is the zero-point error of the vertical encoding circle in relation to the vertical axis of the instrument.

The V-index error is set to "0.00" before delivery.

All vertical angles are corrected with the V-index error.

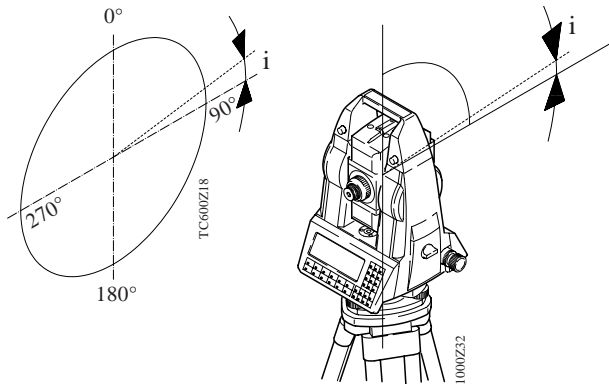

To determine the V-index error, aim the telescope at a target about 100m distant. The target must be positioned within $\pm 9^\circ$ (± 10 gon) of the horizontal plane.

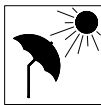

1.

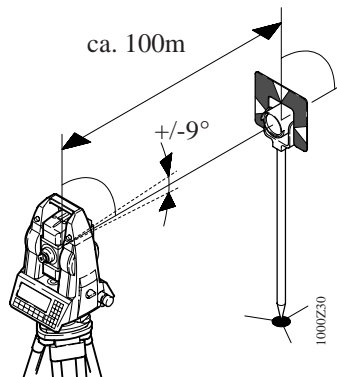

Activate the calibration procedure (*Refer to display on page 176*). The two-axis compensator is turned off automatically when determining the V-index error.

This fact is shown by the  symbol.

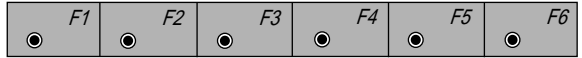
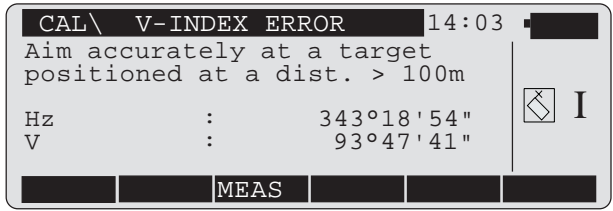

Starts the measurement for the vertical circle. Afterwards, the display shows a message asking for the telescope to be turned to the other face.

2.

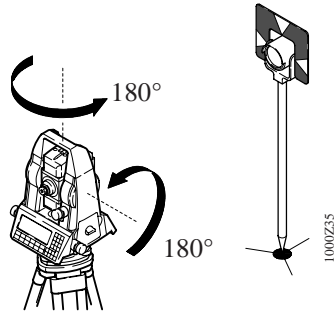

Motorized instruments automatically change face directly after the first measurement has ended. The user must only perform the fine adjustment before proceeding.

CA

If the differences between the horizontal and vertical angles do not exceed $\pm 27'$ (± 0.5 gon), the display shows that the instrument is ready to measure. The user is made aware by an acoustic signal that the  key is redefined as 'OK'.

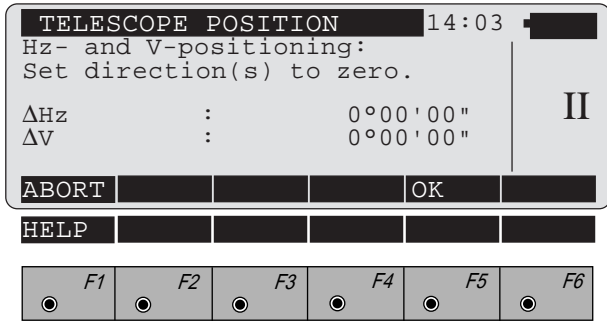

F5 Confirms the readiness to measure and changes the display.

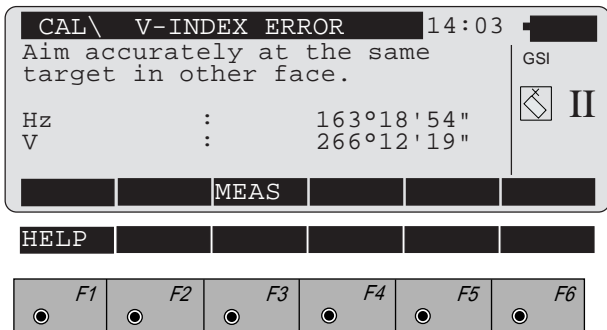

Sight the target accurately again.

F3 Start the second measurement.

After the measurements are complete, the older and newly-determined V-index errors are displayed.

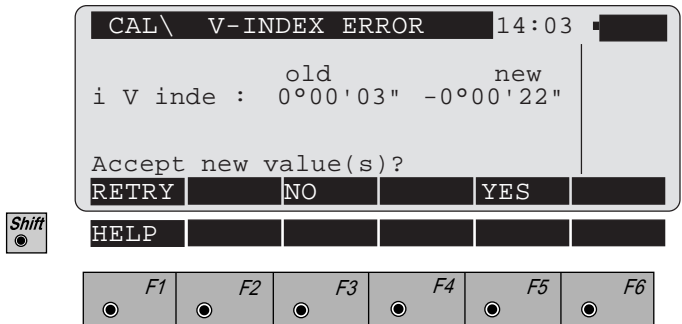

 **F1** Repeats the complete V-index error determination procedure.

 **F3** Leaves the old values unchanged.

 **F5** Stores the new values.



If the value of the V-index error (**i**) exceeds 54' (1 gon) you should repeat the measurement procedure. If this value is exceeded repeatedly, please contact service.

Line of sight

The line-of-sight error c is the divergence of the line of sight from a line perpendicular to the tilting axis. The line-of-sight error is adjusted and reduced to "0.00" before delivery from the factory.

Horizontal angles are only corrected by this line of sight error when the correction is turned "ON".

This correction can be selected after pressing the  direct key (Refer to chapter "Compensator/ Hz-corrections" on page 132).

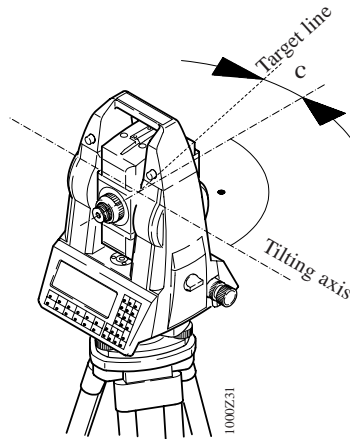

CA

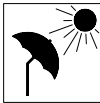

To determine the line-of-sight error, aim the telescope at a target about 100m distant. The target must lie within $\pm 9^\circ$ (± 10 gon) of the horizontal plane.

The procedure is analogous to that of determining the V-index error.



Activates the calibration procedure. (Refer to display on page 176).

The two-axis compensator is turned off automatically when determining the line-of-sight error.

This fact is shown by the  symbol.

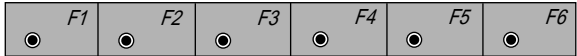
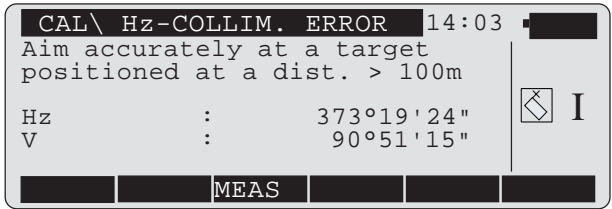

Perform the measurement.

Afterwards, a message in the display prompts you to change telescope face.

Motorized instruments change face automatically immediately after completing the initial measurement. The user is afterwards required to aim the telescope precisely at the target.

If the differences between the horizontal and vertical angles do not exceed $\pm 27'$ (± 0.5 gon), the display shows that it is ready to measure. The user is made aware by an acoustic signal that the  key is redefined as "OK".

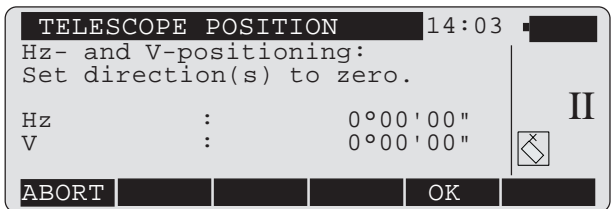

CA



-  **F5** Confirms readiness to measure and changes to the measuring menu.

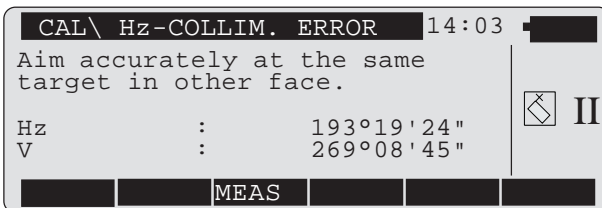

 **Shift**

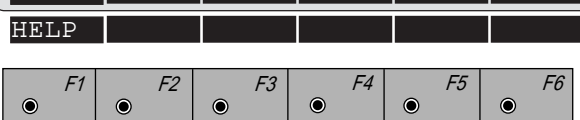

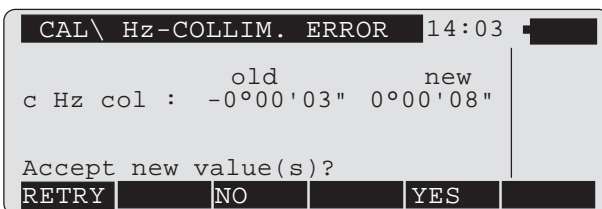

Sight the target accurately.

-  **F3** Perform the second measurement. After successful completion of the second measurement, the older and the newly-determined line-of-sight errors are displayed.

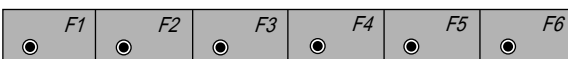

 **Shift**



-  **F1** Repeats the complete line-of-sight error determination procedure.

-  **F3** Leaves the old values unchanged.

-  **F5** Stores the new values.



If the value of the line-of-sight error (c) exceeds 5' 24" (0.1 gon) the collimation error is to be redetermined. If the limit is repeatedly exceeded, please notify service.

Afterwards, the tilting-axis error of the Series 1700, 1800 and 2003 instruments can be determined.

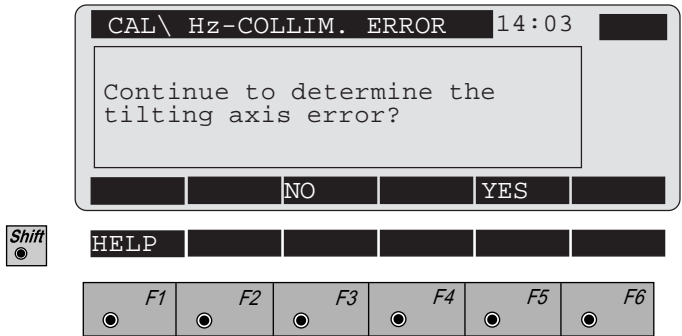

 **F5** Confirms that the tilting-axis error should also be determined.

 **F3** Ends the function and returns to the calibration dialog.

Tilting axis

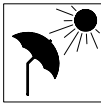
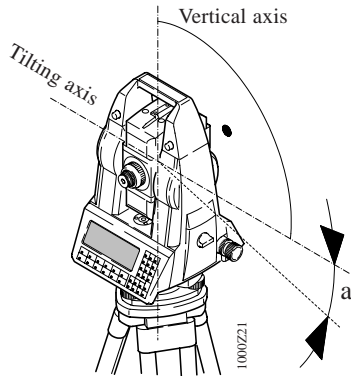

The tilting-axis error **a** is the deviation of the tilting axis from a line perpendicular to the vertical axis. The tilting-axis error is adjusted to "0.00" before delivery.

The horizontal angles are only corrected by the tilting axis error when the Hz-correction is turned "ON". This correction can be made using the  direct key (Refer to chapter "Compensator / Hz-corrections" on page 132).



To determine the tilting-axis error, aim the telescope at a target about 100m distant. The target must be positioned at least $\pm 27^\circ$ (± 30 gon) above or beneath the horizontal plane. The two-axis compensator is turned off automatically during determination of the tilting-axis error.

This fact is shown by the  symbol.

CAL \ TILTING-AXIS ERROR		14:03			
Aim accur. at high/low target positioned at a dist. > 100m					
Hz	:	373°19'24"	 I		
V	:	90°51'15"			
MEAS					
HELP					
F1	F2	F3	F4	F5	F6



Start measurement. Afterwards, a message in the display prompts the user to change telescope face.

Motorized instruments automatically change face directly after performing the initial measurement. The user need only perform any fine aiming necessary.

If the differences between the horizontal and vertical angles do not exceed $\pm 27'$ (± 0.5 gon), the display shows that it is ready to measure. The user is made aware by an acoustic signal that the  key is redefined as "OK".

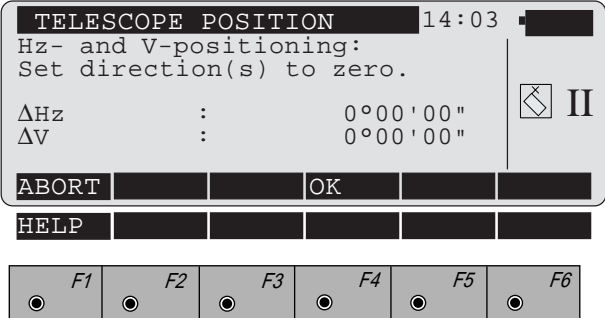

TELESCOPE POSITION 14:03

Hz- and V-positioning:
Set direction(s) to zero.

ΔHz : 0°00'00"
ΔV : 0°00'00"

ABORT OK

HELP

F1 F2 F3 F4 F5 F6

 Confirms readiness to measure and the display changes as follows.

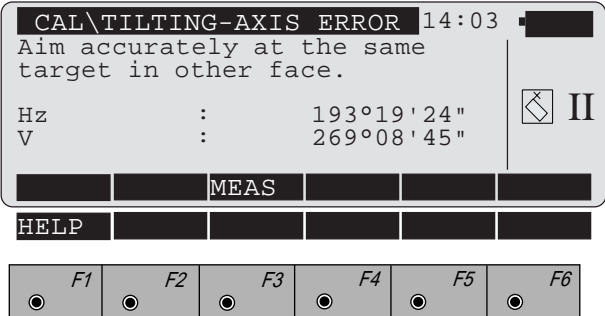

CAL\TILTING-AXIS ERROR 14:03

Aim accurately at the same
target in other face.

Hz : 193°19'24"
V : 269°08'45"

MEAS

HELP

F1 F2 F3 F4 F5 F6

Sight the target accurately.

 Performs the second measurement of the horizontal angle.

After completing the second measurement, the old and newly-determined tilt-axis errors **a** are displayed.

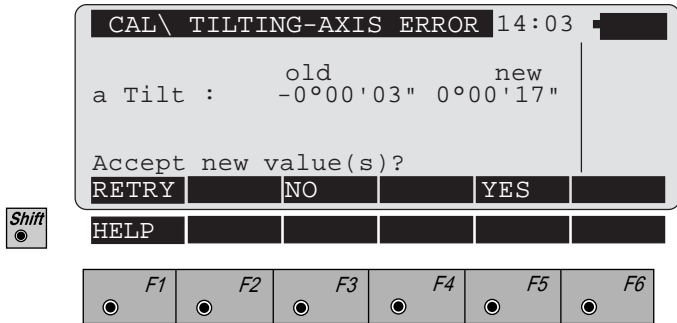

Repeats the complete tilting-axis error determination procedure.



Leaves the old values unchanged.



Stores the new values.



If the value of the tilting axis error (**a**) exceeds 5' 24" (0.1 gon) the measurements are to be repeated. If this occurs repeatedly, please notify service.

Combined error determination

By pressing the  key in the *display page on 176*, it is possible to jointly determine the V-index- and line-of-sight errors (**i/c**) for the Series 1100 instruments and the V-index-, line-of-sight-, and tilting-axis errors (**i/c/a**) for the Series 1700, 1800 and 2003 instruments in just one procedure.

The V-index and line-of-sight errors can be determined using a common target which does not lie more than $\pm 9^\circ$ (± 10 gon) away from the horizontal plane. The determination of the tilting-axis error requires a target which lies at least $\pm 27^\circ$ (± 30 gon) above or beneath the horizontal plane.

For exact procedural details, please refer to the previous chapters.

ATR1 collimation

(Available for TCA versions only)

The ATR1 collimation error is the combined horizontal and vertical angular divergence of the line of sight from the axis of the CCD camera.

The collimation procedure includes, optionally, the determination of the line-of-sight error and the vertical-index error.

The correction for the ATR1 collimation errors is always applied regardless of the "ON/OFF" status of the Hz-correction setting. (*see chapter "Compensator / Hz corrections" on page 132*).

CA

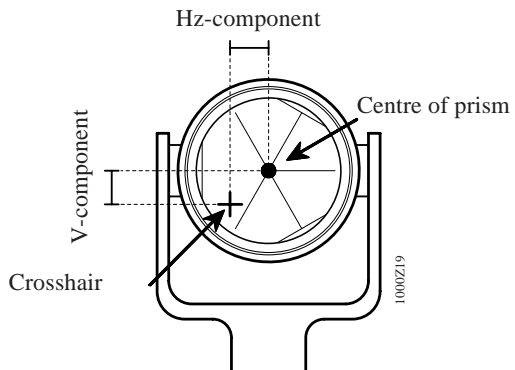

To define the ATR1 collimation error, a prism can be accurately targeted at a distance of about 100 m. The target must lie within $\pm 9^\circ$ (± 10 gon) of the horizontal plane. The procedure is analogous to that of determining the V-index error.



Activates the calibration procedure (Refer to display on page 176). The ATR1 target recognition is automatically switched on. This fact is shown by the  symbol. The display shows the current horizontal and vertical ATR1 collimation errors.

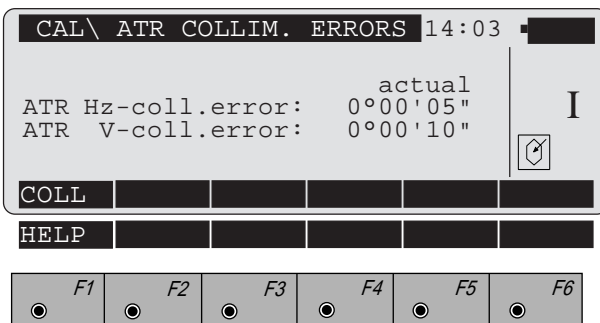

or



Starts the calibration.

The two-axis compensator is turned off automatically when determining the ATR1 collimation error.

This fact is shown by the  symbol.

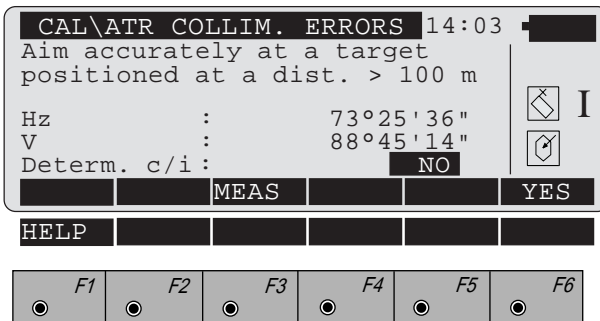

Sight the prism accurately with the crosshair.



Starts the measuring procedure.



Toggles between simple and combined error determination.

YES = Simultaneous determination of ATR1-collimation error, line-of-sight error and vertical-index error

NO = Only determination of ATR1-collimation



It is advisable to determine the ATR1-collimation error, the line-of-sight error and the vertical-index error at the same time.



It is important to perform the procedure for determining the instrument errors very carefully and with highest precision.

Changes face automatically directly after completing the initial measurement.

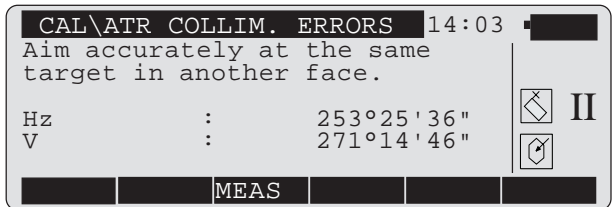

CA

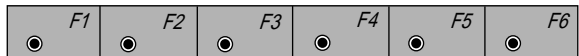

Sight the prism accurately with the crosshair.



Performs the second-face measurement of the collimation errors.

When the second measurement has been taken, the accuracy of ATR1 and, if previously selected, the accuracy of the index and the line-of-sight errors are displayed.

CAL \ ATR ACCURACY		14:03	
No. of Meas :	2		
σ ATR Hz :	0°00'05"		
σ ATR V :	-0°00'08"		
σ V-Index :	----		
σ Hz-col :	----		
Perform further measurements?			<input type="checkbox"/>
ABORT	NO	YES	

Shift

HELP

F1 F2 F3 F4 F5 F6

F1

The calibration process is interrupted. The old values will be left intact.

F3

No further repeat measurements are required. The old and the newly-defined ATR1 collimation errors become optional, and are displayed together with the line-of-sight errors (c) and the V-index errors (i).

F5

The calibration can be repeated as often as necessary until the required level of accuracy is obtained. The result is the mean of all the measurements taken. It is recommended that at least 2 measuring sequences be carried out.

CAL \ ATR COLLIM. ERRORS		14:03	
	old	new	
ATR Hz-c :	0°00'08"	0°00'05"	
ATR V-indx :	0°00'10"	0°00'09"	
i V-indx :	0°00'00"	0°00'10"	<input type="checkbox"/> II
c Hz-col :	0°00'10"	0°00'02"	<input type="checkbox"/>
Accept new value(s)?			
RETRY	NO	YES	

Shift

HELP

F1 F2 F3 F4 F5 F6

F1

Repeats the ATR1 error determination procedure.



Leaves the old values unchanged.



Stores the new values.

If the differences between the horizontal and vertical angles exceed $\pm 27'$ (± 0.5 gon), the display gives an error message. The user is made aware of this by an acoustic signal and the  key is redefined as "OK". The measurement procedure can be repeated.



If the value of the ATR1 horizontal and vertical collimation errors exceeds $2' 42''$ (0.05 gon), repeat the measurement procedure.

Similarly, if the value of the V-index error (**i**) exceeds $54'$ (1 gon) or if the value of the line-of-sight error (**c**) exceeds $5' 24''$ (0.1 gon), the measurements are to be repeated.

If these values are exceeded repeatedly, please contact service.

Mechanically

Tripod

The connections between timber and metal must always be firm and tight.

- Moderately tighten the Allen screws (2).
- Tighten articulated joints (1) just enough to keep the tripod legs open when you lift the tripod off the ground.

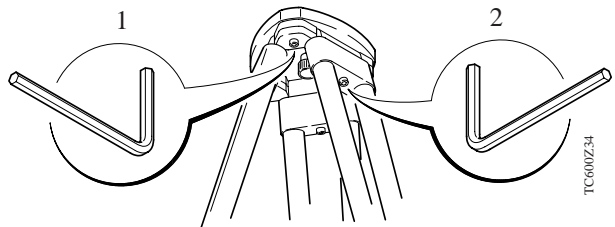

Bull's eye bubble on instrument

Level-up the instrument in advance with the electronic bubble. The bubble must be centred. If it extends beyond the circle, use the adjusting pin supplied to centre it with the adjustment screws. After adjustment no screw must be loose.

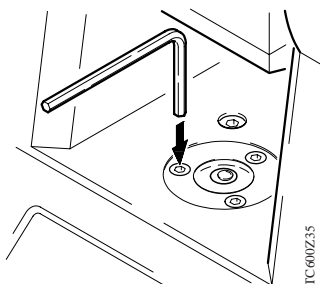

Bull's eye bubble on the tribrach

Level the instrument and then remove it from the tribrach. If the bubble is not centred, adjust it using the adjusting pin in connection with the two cross-headed adjustment screws.

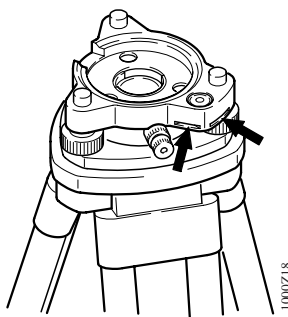

Turning the adjustment screws:

- to the left: the bubble approaches the screw
- to the right: the bubble goes in the other direction.

After adjustment no screw must be loose.

Optical plummet

Check the optical plummet of the tribrach at regular intervals. Any deviation of the line-of-sight from the vertical axis of the instrument causes a centring error.

Checking by plumb-bob:

Set-up and level the instrument on the tripod. Check the centring sleeve for eccentricity by hanging it in place in various positions, then mark the ground point. Remove the plumb-bob. Check that the crosshairs of the optical plummet intersect at the ground point. The accuracy achievable is about 1mm.

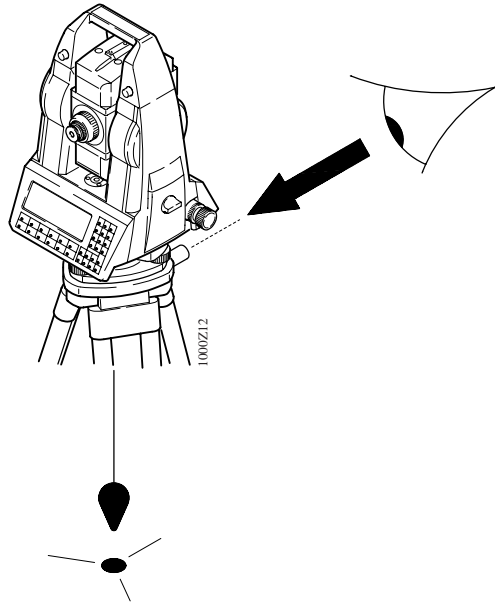

Checking by turning the tribrach:

1. Level-up the instrument using the electronic bubble. Mark the ground point. Using a soft, well-sharpened pencil, mark the outline of the tribrach on the tripod plate.
2. Turn the tribrach 120° and level-up the instrument, fit it into the outline, and again mark the ground point.
3. Repeat again in the third position.

If the three points do not coincide, adjust the crosshairs to the centre of the triangle formed by the three ground points.

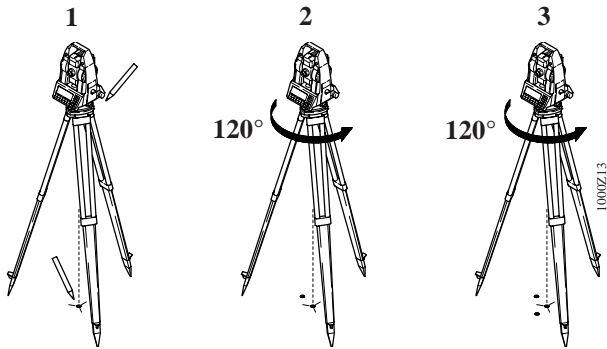

Adjustment:

Use a screwdriver to turn the two set screws alternately by the same small amount in order to centre the crosshairs on the ground point marked.

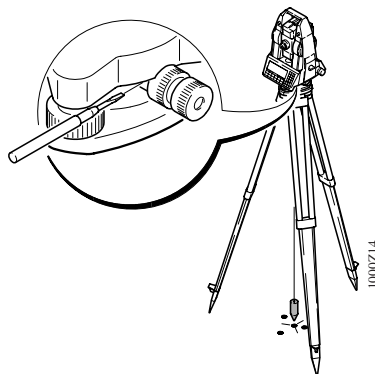

Laser plummet

The laser plummet is located in the standing axis of the instrument.

Under normal conditions of use the laser plummet does not need adjusting.

Inspecting by turning the plummet 360°:

1. Place the instrument on the tripod and level it up.
2. Switch on the laser plummet and mark the centre of the red dot.
3. Slowly turn the instrument through 360°, carefully observing the movement of the red laser dot.

Inspecting the laser plummet should be carried out on a bright, smooth and horizontal surface (e.g. a sheet of paper).

If the centre of the red dot clearly moves in a circle, get the laser plummet adjusted in your local Leica service workshop.

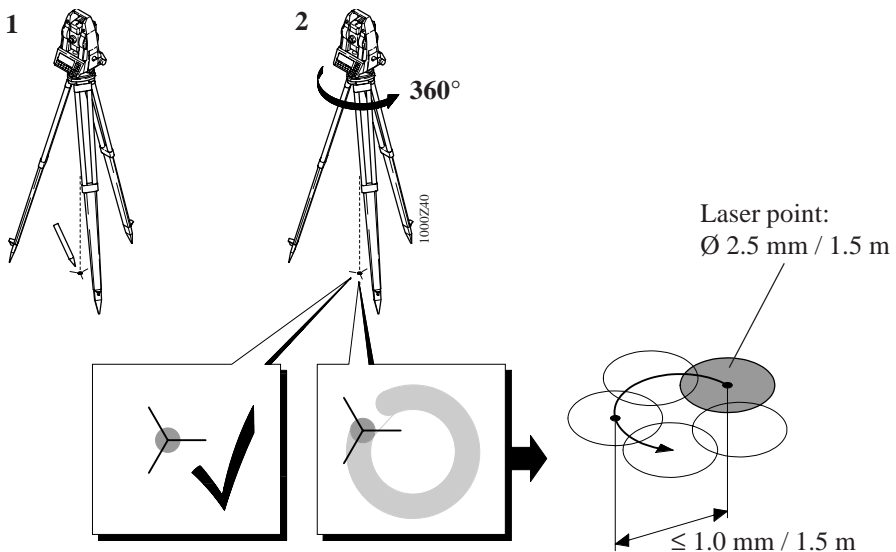

Depending on brightness and surface the size of the laser point can vary. At a distance of 1.5 m an average value of 2.5 mm diameter must be estimated.

The max. diameter of the circular movement of the centre of the laser point should not exceed 1 mm at a distance of 1.5 m.

Transport

When dispatching the instrument, always use the complete original Leica packaging (case and cardboard box).



If a distance measuring device is mounted on a theodolite both instruments must be packed separately in their own transport case. The distance measuring device mounted on the telescope can cause inadmissible loads to the tilting-axis bearing during transport resulting in misadjustments and in damage to the bearing.

When transporting the instrument in the field, always make sure that you:

- either carry the instrument in its original transport case
- or carry the tripod with its legs splayed across your shoulder, keeping the attached instrument **upright**.

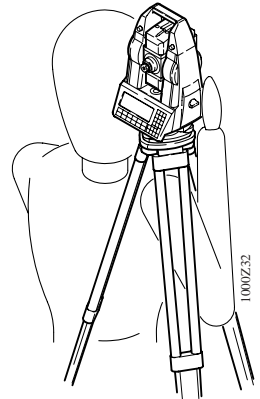
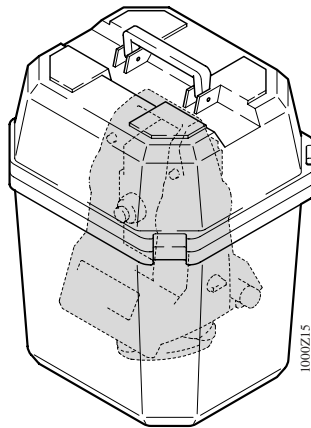

Cleaning and drying

Objective, eyepiece and prisms:

- Blow dust off lenses and prisms.
- Never touch the glass with your fingers.
- Use only a clean, soft, lint-free cloth for cleaning.
If necessary, moisten the cloth with pure alcohol.
Use no other liquids; these may attack the polymer components.



When storing the equipment, particularly in summer and inside a vehicle, take the storage temperature limits into account. (-40°C to +70°C / -40°F to +158°F)



PCMCIA card, cables and plugs

Keep plugs clean and dry. Blow away any dirt lodged in the plugs of the connecting cables. Unplugging connecting cables or removing the PCMCIA card during the measurement may cause loss of data. Always switch off the instrument before removing the cables or the PCMCIA card.



Fogging of prisms

Reflector prisms that are cooler than the ambient temperature tend to fog. It is not enough simply to wipe them. Keep them for some time inside your jacket or in the vehicle to allow them to adjust to the ambient temperature.



Storage

If the instrument becomes wet, leave it unpacked. Wipe down, clean and dry the instrument (at not more than 40 °C/ 108°F), transport case, foam inserts, and accessories. Pack up the equipment only when it is perfectly dry.

Battery charging



WARNING:

The battery chargers are intended for indoor use only. Use a battery charger in a dry room only, never outdoors. Charge batteries only at an ambient temperature between 10°C and 30°C (50°F to 86°F). We recommend a temperature of 0°C to +20°C (32°F to 68°F) for storing the batteries.

Battery chargers GKL22 and GKL23

Charger GKL22:

The charger provides a constant current and charges a NiCd battery within 14 hours. The charging procedure starts automatically whenever a battery is connected to the charger and a red control lamp indicates a fully charged battery.

Charging batteries with 2 pole plug requires an adapter cable.

Fast charger GKL23:

Fast charging with the GLK-23 is possible with Leica NiCd-batteries equipped with a 5-pole plug. Fast charging requires 1.5 to 5 hours depending on the battery capacity.

Leica batteries with 2-pole plugs can be charged using an adapter cable - this charging procedure will take 14 hours.

Connecting 2 batteries at the same time will charge the batteries sequentially. Batteries with fast charging capabilities are priority.

Charging modes and status of the GKL-23 are shown by three-colour LEDs.

For more information about use, functions and displays refer to the user manual of the GKL-23.

Battery chargers GKL12 and GKL14

If you already own one of these battery chargers, we recommend:

- the charger GKL12 for charging the total station's battery insert (2-pole charging plug) and the GEB70 compact battery.
- For the GEB71 universal battery, use a GKL14 charger.

Before you use new batteries for the first time, charge them for 20 to 24 hours. This also applies to batteries that have not been used for several months. NiCd batteries reach full capacity after two or three normal cycles each of a 14-hour charge followed by a full discharge

If battery performance drops noticeably, run one or two full cycles, i.e. charge for 14 hours and then discharge it until the message 53 appears: "Battery almost flat. Change battery".

Leave flat batteries to charge for fourteen hours. If you do not know a battery's state of charge, also leave it to charge for fourteen hours.

Set the battery charger's voltage selector to your AC grid voltage, **115V** or **230V**. Plug in the charger to the power. The green indicator lamp should light. If it does not light, there is a power cut or the power cable or charger is faulty.

Connect the battery to the charger. The red charging indicator should light. If it does not, the battery is not charging, i.e. the battery cable is faulty or the battery fuse has blown and should be replaced. On the GKL12, you may not have started the timer or it may have stopped at the end of the charging period.

Data format

Introduction

This chapter describes the data structure and organization of the Leica GSI (Geo Serial Interface). The GSI data structure is used for all data transferred between the Leica electronic survey instruments, and also defines the data stored internally. The following information describes the data structure of the TPS1000 instruments and contains some specific features only applicable to these instruments.

Data transferred between a Leica instrument and a computer will conform to the GSI data structure (also called GSI data format).

GSI storage format with 8 or 16 characters

From Version 2.20 onwards, there is a choice of two GSI formats, with word lengths of 8 and 16 characters respectively. When 16 characters are stored and supported the following special conditions apply:

A measurement block is tagged with * at the first position.

A data word includes the data at positions 7 to 23 instead of at 7 to 15.

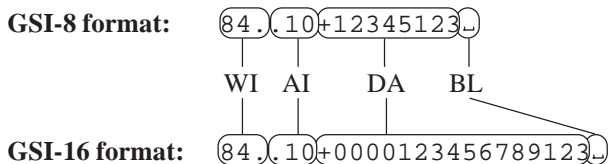

DF

- WI Word index
- AI Additional information
- DA Data
- BL Blank = separating character

Block concept

Data transmitted by instruments over the GSI interface is composed of blocks. Each one of these data blocks is treated as a whole, and ends with a terminator (CR, or CR LF). There are two types of data block:

- 1 Measurement blocks
- 2 Code blocks

Measurement blocks contain a point number and measurement information. They are designed primarily for triangulation, traverse, detail, and tacheometric surveys.

Code blocks are designed primarily for recording identification codes, data-processing codes and information. However, they can also be used for recording measurement information such as instrument and target heights, and tie distances.

Each data block has a block number. The block numbers start with 1 and are incremented by 1 each time that a new data block is stored.

Structure of a block

A data block consists of words, each with 16 (24) characters. The maximum number of words in the TPS1000 is 12.

Measurement block

The words of a measurement block are determined by the format which is set on the survey instrument.

Example: Measurement block with TPS1000 default values

Wort 1	Wort 2	Wort n	
Punktnummer	Hz-Richtung	V-Winkel	Schrägdistanz	ppm mm	Term

Code block

Wort 1	Wort 2	Wort n	
Codenummer	Info1	Info2		Info n	Term

The first word of a code block is always the code number. A code block can contain between one and eight words.

Terminator of a data block

The terminator is sent by the instrument after data blocks, after the response sign (?) and after other messages.

The standard terminator is CR/LF (carriage return/line feed). TPS1000 instruments can be set to transmit and accept only CR.

Structure of a word

Each word has a fixed length of 16 (24) characters.

W1	w2	+	1	2	3	4	5	6	7	8	↵
1	2	3	4	5	6	7	8	9	10	11	12	13	14	15	16

Position	Meaning
1 - 2	Word index
3 - 6	Information relating to data
7 - 15 (23)	Data
16(24)	Blank = separating character

Word index
(positions 1 - 2)

Each word has a two-digit word index to identify it. These two digits occupy the first two positions of the word. Word index numbers lie in the range 01 to 99. The word indices are listed on the following pages. In some applications special word indices are used. They are described in the application manuals.

WORD-INDEX TABLE

Word index	Description
General	
11	Point number (includes block number)
12	Instrument serial number
13	Instrument type
18	Time format 1, pos. 8-9 year, 10-11 seconds, 12-14 msec
19	Time format 2, pos. 8-9 month, 10-11 day, 12-13 hour, 14-15 min
Angle	
21	Horizontal circle (Hz)
22	Vertical angle (V)
Distances	
31	Slope distance
32	Horizontal distance
33	Height difference

Word index	Description
Code blocks	
41	Code number (includes block number)
42 - 49	Information 1-8
Additional distance information	
51	Constants (ppm,mm)
52	Number of measurements, standard deviation
53	Signal strength
58	Reflector constant (1/10mm)
59	ppm
Remarks	
71 - 79	Rem 1-9
Coordinates	
81	Easting (target)
82	Northing (target)
83	Elevation (target)
84	Station easting (Eo)
85	Sation northing (No)
86	Station elevation (Ho)
87	Reflector height (above ground)
88	Instrument height (above ground)



All words can be used in measurement blocks except words 41 - 49, which are reserved.

A code block begins with 41, the word index for a code number.

Information relating to data (positions 3 - 6)

Positions 3 to 6 contain information which relates to the data in positions 7 to 15 (23).

Position in word	Explanation	Applicable to
3	Extension for word index	Digital level
4	Compensator information 0 Automatic height index and monitoring of levelling up: OFF 3 Automatic height index and monitoring of levelling up: ON	All words containing angle information
5	Input mode 0 Value measured automatically 1 Manual input from keyboard 2 Angle: Hz-correction for tilt of standing axis: ON Distance: Correction for measurement to vertical prism 3 Angle: Hz-correction for tilt of standing axis: OFF 4 Result calculated from functions	All words containing measured data

Position in word	Explanation	Applicable to
6	Units 0 Metre (last digit = 1mm) 1 US-Feet (last digit = 1/1000ft) 2 400gon 3 360° decimal 4 360° sexagesimal 5 6400 mil 6 Metre (last digit = 1/10mm) 7 US-Feet (last digit = 1/10000ft) 8 Metre (last digit = 1/100mm)	All words containing measured data



A point in any of the positions 3 to 6 means that there is no information.

In the words for point number (WI = 11) and code (WI = 41), positions 3 to 6 contain the block number.

Data (positions 7 - 15/23)

Position in word	Explanation	Applicable to
7	Sign + positive - negative	All words
8-15 (23)	The data comprises 8 (16) numeric or alphanumeric characters Note that certain words can contain two data blocks, i.e. pairs. These are transferred automatically, complete with signs, from the survey instrument: e.g. 0123 -035 ppm mm	All words containing data Words 51 - 59

Separating character
(position 16/24)

Position in word	Explanation	Applicable to
16 (24)	Blank (separating character)	All words



The last data word of a block must also contain the separating character and CRLF.

Block number

Each data block is allocated a block number by the recording device. Block numbers start at 1 and increment automatically.

The block number is contained in the first word of the block. The first word of a measurement block is the point number (WI = 11). The first of a code block is the code number (WI = 41).

The structure of the first word of a data block is as follows:

Position	Explanation in word
1 - 2	Word index 11 or 41
3 - 6	Block number (assigned by recording device)
7	Sign + or -
8 - 15 (23)	Point number, code number or text
16 (24)	Blank = separating character

Units of measurement

The GSI data format does not contain a decimal point. On transferring data to the computer, the decimal point must be inserted by the computer in accordance with the units indicated in position 6 of the word.

Position 6 in data word	Units	Places before point	Places after point	Example
0	Metre (last digit = 1mm)	5	3	12345.678
1	Feet (last digit = 1/1000ft)	5	3	12345.678
2	400gon	3	5	123.45678
3	360° decimal	3	5	123.45678
4	360° sexagesimal	3	5	123.45123
5	6400 mil	4	4	1234.5678
6	Metre (last digit = 1/10mm)	4	4	1234.5678
7	Feet (last digit = 1/1000ft)	4	4	1234.5678
8	Metre (last digit = 1/100mm)	3	5	123.45678

Example of data format

This section describes the types of data measured and transmitted by an electronic theodolite.

Format of a theodolite measurement block

Word 1	Word 2	Word 3	Word 4	Word 5
Point No	Hz circle	V circle	Slope distance	ppm mm

The following table shows the structure of a measurement block for 8 characters:

Word	Position	Explanation	Characters
Point number	1 - 2	Word index for point number	11
	3 - 6	Block number (set by recording device)	num
	7	Sign	+,-
	8 - 15	Point number	α num
	16	Blank = separating character	↵
Hz circle	17 - 18	Word index for Hz circle	21
	19	Reserved	.
	20	Automatic index information	2, 3
	21	Input mode	0 - 4
	22	Units	2,3,4,5
	23	Sign	+,-
	24 - 26	Degrees	num
	27 - 28	Minutes (resp. 1/100 grad)	num
	29 - 31	Seconds (resp. 1/10000 grad)	num
	32	Blank = separating character	↵

DF

Word	Position	Explanation	Characters
V circle	33 - 34	Word index for V circle	22
	35	Reserved	.
	36	Automatic index information	2, 3
	37	Input mode	0 - 4
	38	Units	2,3,4,5
	39	Sign	+,-
	40 - 42	Degrees	num
	43 - 44	Minutes (or 1/100 grad)	num
	45 - 47	Seconds (or 1/10000 grad)	num
	48	Blank = separating character	↵
Slope distance	49 - 50	Word index for slope distance	31
	51 - 52	No significance	..
	53	Input mode	0, 2
	54	Units	0,1
	55	Sign	+,-
	56 - 60	Metres/feet	num
	61 - 63	Decimals of metre/foot	num
	64	Blank = separating character	↵
ppm mm	65 - 66	Word index for ppm, mm	51
	67 - 70	No significance
	71	Sign	+,-
	72 - 75	ppm	num
	76	Sign	+,-
	77 - 79	mm	num
	80	Blank = separating character	↵
End	81	Carriage Return	CR
Char	(82)	Line Feed	LF

DF

Format of a code block

Word 1	Word 2	Word 5
Code No	Info 1	Info 4

The table below shows in detail the layout of a code block:

Word	Position	Explanation	Characters
Code-number	1 - 2	Word index for code number	41
	3 - 6	Block number (set by recording instrument)	num
	7	Sign	+,-
	8 - 15	Code number	α num
	16	Blank = separating character	↵
Information 1	17 - 18	Word index for Information 1	42
	19 - 22	No significance	...
	23	Sign	+,-
	24 - 31	Information 1	α num
Information 2	32	Blank = separating character	↵
	33 - 34	Word index for information 2	43
	35 - 38	No significance	...
	39	Sign	+,-
	40 - 47	Information 2	α num
Information 3	48	Blank = separating character	↵
	49 - 50	Word index for information 3	44
	51 - 54	No significance	...
	55	Sign	+,-
	56 - 63	Information 3	α num
Information 4	64	Blank = separating character	↵
	65 - 66	Word index for information 4	45
	67 - 70	No significance	...
	71	Sign	+,-
	72 - 79	Information 4	α num
End Char	80	Blank = separating character	↵
	81	Carriage return	CR
	(82)	Line feed	LF

DF

Safety directions

The following directions should enable the person responsible for the TPS-System 1000, and the person who actually uses the instrument, to anticipate and avoid operational hazards.

The person responsible for the instrument must ensure that all users understand these directions and adhere to them.

Intended use of instrument

Permitted uses

The TPS-System 1000 electronic theodolites and total stations are intended for the following applications:

- Measuring horizontal and vertical angles
- Measuring distances (TC-models with integrated distance meter, T-models with removable distance meter)
- Recording measurements
- Computing by means of application software
- Automatic target recognition (with ATR1)
- Visualizing the aiming direction (with EGL1 guide light)
- Visualizing the standing axis (with the laser plummet).
- Navigating machines by determination of position (safety functions must be guaranteed by the higher machine control system).

SD

Adverse uses

- Using the electronic theodolite or total station without previous instruction
- Use outside of the intended limits
- Disabling safety systems and removal of hazard notices
- Opening the instrument using tools (screwdriver, etc.), unless this is specifically permitted for certain functions
- Modification or conversion of the instrument
- Use after misappropriation
- Use with accessories from other manufacturers without the prior express approval of Leica
- Aiming directly into the sun
- Inadequate safeguards at the measuring station (e.g. when measuring on roads, etc.)
- Controlling machines, moving objects or similar with the automatic target recognition ATR1.



WARNING:

Adverse use can lead to injury, malfunction, and damage. It is the task of the person responsible for the instrument to inform the user about hazards and how to counteract them. The TPS-System 1000 electronic theodolites and total stations are not to be used until the user has been properly instructed how to use them.

Limits of use

Environment:

Suitable for use in an atmosphere appropriate for permanent human habitation: not suitable for use in aggressive or explosive environments. Use in rain is permissible for limited periods.

See chapter "Technical specifications".

Responsibilities

Area of responsibility for the manufacturer of the original equipment:

Leica Geosystems AG, CH-9435 Heerbrugg (hereinafter referred to as Leica):

Leica is responsible for supplying the product, including the user manual and original accessories, in a completely-safe condition.

Responsibilities of the manufacturers of non-Leica accessories:

The manufacturers of non-Leica accessories for the TPS-System 1000 electronic theodolite and total stations are responsible for developing, implementing, and communicating safety concepts for their products, and are also responsible for the effectiveness of those safety concepts in combination with the Leica product.

Responsibilities of the person in charge of the instrument:



WARNING:

The person responsible for the instrument must ensure that it is used in accordance with the instructions. This person is also accountable for the training and the deployment of personnel who use the instrument and for the safety of the equipment in use.

The person in charge of the instrument has the following duties:

- To understand the safety instructions on the product and the instructions in the user manual;
- To be familiar with local regulations relating to accident prevention;
- To inform Leica immediately if the equipment becomes unsafe.

SD

Main hazards of use**WARNING:**

The absence of instruction, or the inadequate imparting of instruction, can lead to incorrect or adverse use, and can give rise to accidents with far-reaching human, material, financial, and environmental consequences.

Precautions:

All users must follow the safety directions given by the manufacturer and the directions of the person responsible for the instrument.

**WARNING:**

The charger and the PCMCIA-card reader must not be used in damp or inclement conditions. If moisture penetrates these devices, the user may receive an electric shock.

Precautions:

Use the charger and the PCMCIA-card reader only indoors, in dry rooms. Protect them from damp. If the devices are damp, do not use them.

**WARNING:**

If you open the charger or the PCMCIA-card reader, either of the following actions may cause you to receive an electric shock:

- Touching live components;
- Using the devices after incorrect attempts to carry out repairs.

Precautions:

Do not open the charger or PCMCIA-card reader yourself. Only a Leica-approved service technician is entitled to repair them.

**CAUTION:**

Watch out for erroneous distance measurements if the product is defective or if it has been dropped or has been misused or modified.

Precautions:

Periodically carry out test measurements and perform the field adjustments indicated in the user manual (*See chapter "Checking and adjusting"*), particularly after the instrument has been subjected to abnormal use and before and after important measurements.

**DANGER:**

Because of the risk of electrocution, it is very dangerous to use reflector poles and extensions in the vicinity of electrical installations such as power cables or electrical railways.

Precautions:

Keep at a safe distance from electrical installations. If it is essential to work in this environment, first contact the safety authorities responsible for the electrical installations and follow their instructions.

**WARNING:**

By surveying during a thunderstorm you are at risk from lightning.

Precautions:

Do not carry out field surveys during thunderstorms.

SD

**CAUTION:**

Be careful not to point the instrument directly towards the sun, because the telescope functions as a magnifying lens and can injure your eyes or damage the internal components of the EDM, ATR1 and EGL1 guide light.

Precautions:

For total stations ATR1, EGL1 (TC-, TCM-, TCA-versions):

Do not point the telescope directly at the sun.

For electronic theodolite (T-, TM-versions):

For observations to the sun or to other highly-reflective objects, use the appropriate accessories.

**WARNING:**

During target recognition or stakeout procedures there is a danger of accidents occurring if the user does not pay attention to the environmental conditions around or between the instrument and the target (e.g. obstacles, excavations or traffic).

Precautions:

The person responsible for the instrument must make all users fully aware of the existing dangers.

**WARNING:**

When using instruments for distance measurements to moving targets (e.g. helicopters, ships and airplanes) or to position moving objects (e.g. cranes, construction machines, rigs) it is possible to get incorrect measurements due to unforeseen events.

Precautions:

Use the EDM or ATR1 only as a measuring sensor and not as a controlling unit. Your system should be set-up and operated with appropriate safety installations (e.g. safety switch), so that no harm can occur as a result of incorrect measurements, disturbances to the instrument, or power interruptions.



WARNING:

Inadequate securing of the surveying site can lead to dangerous situations, for example in traffic, on building sites, and at industrial installations.

Precautions:

Always ensure that the survey site is adequately secured. Adhere to the regulations governing accident prevention and road traffic.



CAUTION:

If a target lamp accessory is used with the instrument the lamp's surface temperature may be extreme after a long working period. It may cause pain if touched. Replacing the halogen bulb before the lamp has been allowed to cool down may cause burning to the skin or fingers.

Precautions:

Use appropriate heat protection such as gloves or woollen cloth before touching the lamp, or allow the lamp to cool down first.

**WARNING:**

If computers intended for use indoors are used in the field there is a danger of electric shock.

Precautions:

Adhere to the instructions given by the computer manufacturer with regard to field use in conjunction with Leica instruments.

**CAUTION:**

During the transport or disposal of charged batteries it is possible for inappropriate mechanical influences to constitute a fire hazard.

Precautions:

Before transporting or disposing of equipment, discharge the battery either by running the instrument in tracking mode until the batteries are exhausted or discharging with the GKL23 battery charger.

**CAUTION:**

If the accessories used with the instrument are not properly secured and the equipment is subjected to mechanical shock (e.g. blows, falling), the equipment may be damaged or people may sustain injury.

Precautions:

When setting-up the instrument, make sure that the accessories (e.g. tripod, tribrach, removable EDM with counterbalance, connecting cables) are correctly adapted, fitted, secured, and locked in position. Avoid subjecting the equipment to mechanical shock. Never position the instrument on the tripod baseplate without securely tightening the central fixing screw. If the screw is loosened always remove the instrument immediately from the tripod.

**WARNING:**

If the equipment is improperly disposed of, the following can happen:

- If polymer parts are burnt, poisonous gases are produced which may impair health
- If batteries are damaged or are heated strongly, they can explode and cause poisoning, burning, corrosion, or environmental contamination
- By disposing of the equipment irresponsibly you may enable unauthorized persons to use it in contravention of the regulations, exposing themselves and third parties to the risk of severe injury and rendering the environment liable to contamination
- Leakage of silicone oil from the compensator can damage the optical and electronic subassemblies.

Precautions:

Dispose of the equipment appropriately in accordance with the regulations in force in your country. Always prevent access to the equipment by unauthorized personnel.

Laser classification

Integrated distancer (EDM)

Total stations (TC, TCM, TCA versions):

The EDM module built into the total stations produces an invisible infra-red beam which emerges coaxially from the telescope objective. The product is a Class 1 LED product in accordance with:

- IEC 825-1 : 1993 "Radiation safety of laser products"
- EN 60825-1 : 1994 "Radiation safety of laser products"

Class 1 LED products are safe under reasonably foreseeable conditions of operation and are not harmful to the eyes provided that the products are used and maintained in accordance with the instructions.

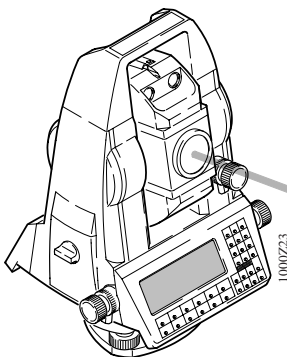
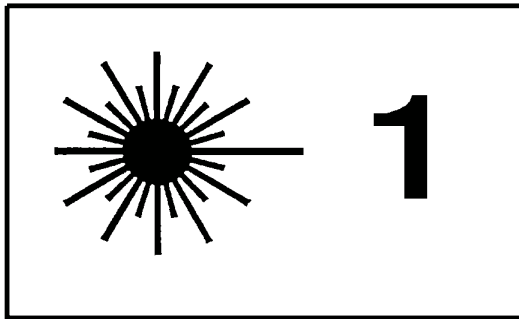

Beam divergence:	1.54 mrad / 2.02 mrad
Impulse duration:	10 ns
Maximum power output:	140 μ W / 360 μ W
Measurement uncertainty:	\pm 5%

Exit for infrared beam
(invisible)

**Automatic target
recognition (ATRI)**

Total stations (TCA versions only):

The integrated automatic target recognition produces an invisible laser beam which emerges coaxially from the telescope objective. The product is a Class 1 laser product in accordance with:

- IEC 825-1 : 1993 "Radiation safety of laser products"
- EN 60825-1 : 1994 "Radiation safety of laser products"

The product is a Class I laser product in accordance with:

- FDA 21CFR Ch.I §1040: 1988 (US Department of Health and Human Service, Code of Federal Regulations)

Class 1/I laser products are safe under reasonably foreseeable conditions of operation and are not harmful to the eyes provided that the products are used and maintained in accordance with the instructions.



WARNING:

It can be dangerous to look into the beam with optical equipment (e.g. binoculars, telescopes)

Precautions:

Do not look directly into the beam with optical equipment.

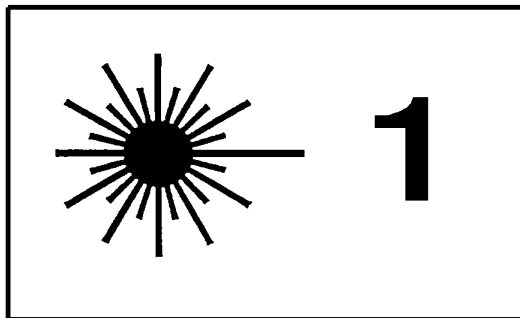

SD

Type: T....

Art.No.:

Power: 12V=nominal, 400mA max.

**Leica Geosystems AG
CH-9435 Heerbrugg
Manufactured:1997**



S.No.:

or

Type: T....

Art.No.:

Power: 12V=nominal, 400mA max.

**This laser product complies with
21 CFR 1040 as applicable**

**Leica Geosystems AG
CH-9435 Heerbrugg
Manufactured:1997**

S.No.:

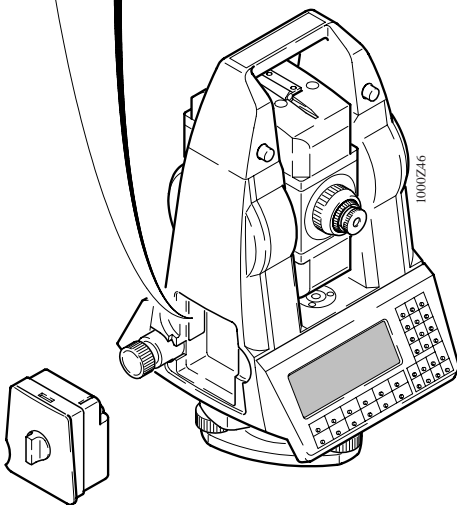

	in accordance with: IEC825-1: 1993 EN60825-1: 1994	in accordance with: FDA 21CFR Ch.I §1040: 1988
Beam divergence	8.7 mrad	8.7 mrad
Impulse duration	5.65 ms	3.65 ms
Maximum power output	780 μ W peak	460 μ W peak
Measurement uncertainty	5%	5%

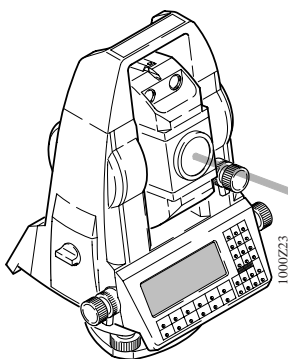

Exit for laser beam
(invisible)

SD

Guide light EGL1

The integrated guide light produces a visible LED beam from the upper front side of the telescope.
The product is a Class 1 LED product *) in accordance with:

- IEC 825-1 : 1993 "Radiation safety of laser products"
- EN 60825-1 : 1994 "Radiation safety of laser products"

*) Within the specified working range of > 5 m (> 16 ft).

Class 1 LED products are safe under reasonably foreseeable conditions of operation and are not harmful to the eyes provided that the products are used and maintained in accordance with the instructions.



CAUTION:

Use the guide light only within the specified working range of > 5 m (> 16 ft) from the telescope.

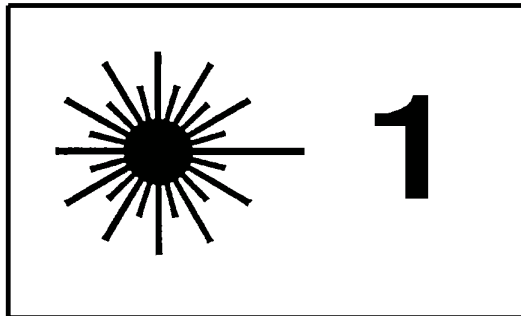

Flashing LED	yellow	red
Beam divergence	2.4 °	2.4 °
Impulse duration	2 x 35 ms	35 ms
Maximum power output	0.55 μ W	1.2 μ W
Measurement uncertainty	\pm 5 %	\pm 5 %

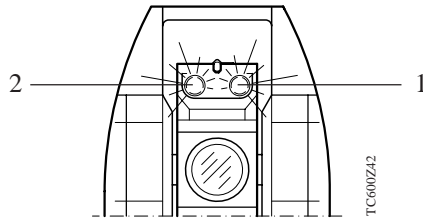

- 1 Exit for flashing red LED
- 2 Exit for flashing yellow LED

Laser plummet
(only Txx xxxxL)

The laser plummet built into the total station produces a visible infrared beam which emerges from the bottom of the instrument. The product is a Class 2 laser product in accordance with:

- IEC 825-1 : 1993 "Radiation safety of laser products"
- EN 60825-1 : 1994 "Radiation safety of laser products"

The product is a Class II laser product in accordance with:

- FDA 21CFR Ch.I §1040: 1988 (US Department of Health and Human Service, Code of Federal Regulations)

Class 2/II laser products: Do not stare into the beam or direct it unnecessarily at other persons. Eye protection is normally afforded by aversion responses including the blink reflex.



WARNING:

It can be dangerous to look into the beam with optical equipment (e.g. binoculars, telescopes)

Precautions:

Do not look directly into the beam with optical equipment.

**Labelling in accordance
with IEC825-1,
EN60825-1**

Max. emitted Power :	0.95mW c.w.
Emitted Wavelength :	620-690nm
Standard applied :	EN60825-1:1994-07 IEC825-1 : 1993-11

Type: T....	Art.No.:
Power: 12V=nominal, 400mA max.	
Leica Geosystems AG	
CH-9435 Heerbrugg	
Manufactured:1997	
CE	
	S.No.:

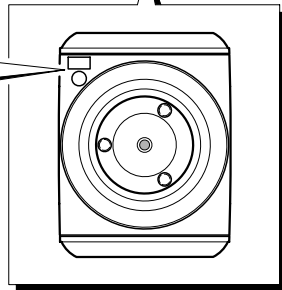
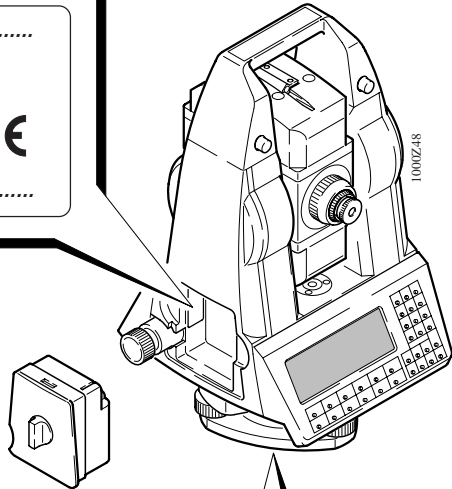

Labelling in accordance
with FDA 21CFR

Type: T.... *Art.No.:*
Power: 12V = nominal, 400mA max.
This laser product complies with
21 CFR 1040 as applicable
Leica Geosystems AG
CH-9435 Heerbrugg
Manufactured: 1997 *S.No.:*

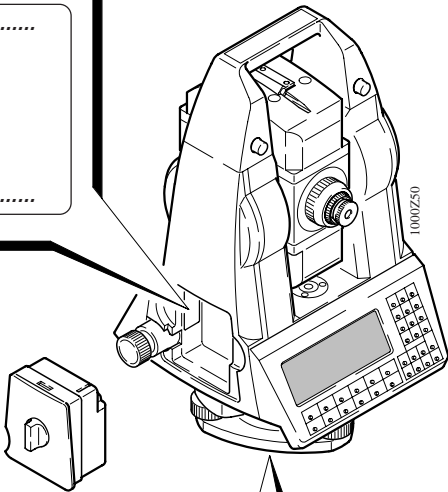

CAUTION
LASER RADIATION - DO NOT
STARE INTO BEAM
 620-690nm/0.95mW max.
CLASS II LASER PRODUCT

AVOID EXPOSURE
Laser radiation is emitted
from this aperture

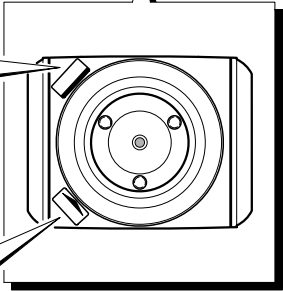

	in accordance with: IEC825-1: 1993 EN60825-1: 1994	in accordance with: FDA 21CFR Ch.I §1040: 1988
Beam divergence: Impulse duration: Maximum power output: Measurement uncertainty:	0.16 x 0.6 mrad c.w. 0.95 μ W \pm 5%	0.16 x 0.6 mrad c.w. 0.95 μ W \pm 5%

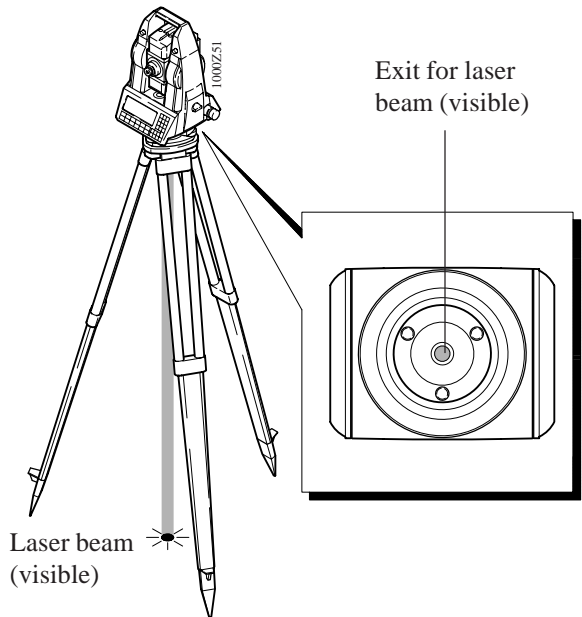

CAUTION:

Allow only authorized Leica service workshops to service the instruments.

SD

The term "electromagnetic acceptability" is taken to mean the capability of the electronic theodolite or total station to function correctly in an environment where electromagnetic radiation and electrostatic discharges are present and without causing electromagnetic disturbances in other equipment.

**WARNING:**

Electromagnetic radiation can cause disturbances in other equipment. Although the electronic theodolites and total stations meet the strict regulations and standards which are in force in this respect, Leica cannot completely exclude the possibility that other equipment may be disturbed.

**CAUTION:**

There is a risk that disturbances may be caused in other equipment if the electronic theodolites or total stations are used in conjunction with accessories from other manufacturers (e.g. field computers, personal computers, portable radios, non-standard cables, external batteries).

Precautions:

Use the equipment only with accessories from Leica. When combined with electronic theodolites or total stations the strict requirements stipulated by the guidelines and standards are assured. When using computers and portable radios, pay attention to the information provided by the manufacturer regarding electromagnetic acceptability.

**CAUTION:**

Disturbances caused by electromagnetic radiation can result in the tolerance limits for measurements being exceeded.

Although the electronic theodolites and total stations meet the strict regulations and standards which are in force in this connection, Leica cannot completely exclude the possibility that an electronic theodolite or total station may be disturbed by very intense electromagnetic radiation, for instance near radio transmitters, portable radios, diesel generators. Check the plausibility of results obtained under these conditions.

**WARNING:**

If an electronic theodolite or total station is operated with cables attached at only one of their two ends (e.g. external power supply cables, interface cables), the permitted level of electromagnetic radiation may be exceeded and the correct functioning of other instruments may be impaired.

Precautions:

While the instrument is in use, cables (e.g. instrument to external battery, instrument to computer) must be connected at both ends.

***FCC statement
(applicable in U.S.)***

**WARNING:**

This equipment has been tested and found to comply with the limits for a Class B digital device, pursuant to part 15 of the FCC rules.

These limits are designed to provide reasonable protection against harmful interference in a residential installation.

This equipment generates, uses and can radiate frequency energy and, if not installed and used in accordance with the instructions, may cause harmful interference to radio communications. However, there is no guarantee that interference will not occur in a particular installation. If this equipment does cause harmful interference to radio or television reception, which can be determined by turning the equipment off and on, the user is encouraged to try to correct the interference by one or more of the following measures:

- Reorient or relocate the receiving antenna.
- Increase the separation between the equipment and the receiver.
- Connect the equipment into an outlet on a circuit different from that to which the receiver is connected.
- Consult the dealer or an experienced radio/TV technician for help.

WARNING:



Changes or modifications not expressly approved by Leica for compliance could void the user's authority to operate the equipment.

Product labeling

This device complies with part 15 of the FCC Rules. Operation is subject to the following two conditions:
(1) This device may not cause harmful interference, and
(2) this device must accept any interference received, including interference that may cause undesired operation.

*This device complies with part 15 of the FCC Rules. Operation is subject to the following two conditions:
(1) This device may not cause harmful interference, and (2) this device must accept any interference received, including interference that may cause undesired operation.*

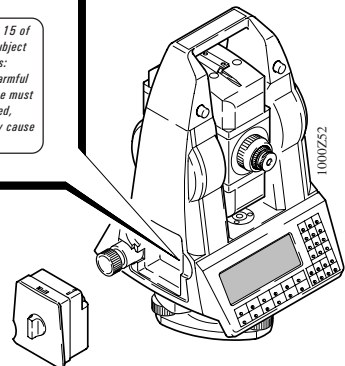

SD

Technical specifications

Angle measurement

Types	Accuracy Hz, V (DIN18723)
1100	3" (1 mgon)
1500	2" (0.6 mgon)
1700	1.5" (0.5 mgon)
1800	1" (0.3 mgon)
2003	0.5" (0.15 mgon)

Display (least count)	1", (0.1mgon)
Type 1100	1" (0.5 mgon)
Type 2003	0.1" (0.01 mgon)
Selection possibilities	360°, 400 gon, V%, 6400 mil
Method	absolute, continuous

Distance measurement **Type:** infrared

Atmospheric conditions	Range		
	1 Standard prism	3 Standard prisms	360° reflector
poor 1)	1200m (4000 ft)	1500m (4900ft)	-----
average 2)	2500m (8200 ft)	3500m (11500ft)	1300 m (4300ft)
excellent 3)	3500 m (11500 ft)	5000m (16400ft)	-----

- 1) Very hazy, visibility 3 km, or strong sunlight and heavy heat shimmer
- 2) Light haze, or some cloud and slight heat shimmer
- 3) Overcast, no haze, visibility 30 km, no heat shimmer

	Accuracy	Time per measurement
Standard measurement	2 mm + 2 ppm Type 1800 1 mm + 2 ppm Type 2003 1 mm + 1 ppm	3 sec.
Fast measurement	3 mm + 2 ppm	1.5 sec.
Tracking	5 mm + 2 ppm	0.3 sec.
Average	-----	3 sec.
Rapid tracking	10 mm + 2 ppm	0.15 sec.
Precision measurement	1 mm + 2 ppm Type 2003 1 mm + 1 ppm	3 sec.

Display (least count): 1mm
Types 1800, 2003 0.1 mm
EDM alignment: coaxial

Telescope

Magnification/Image	30x / erect
Clear objective diameter	42 mm
Shortest sight distance	1.7 m (5.6 ft)
Focusing	fine and coarse
Field of view	1° 33'
Transit	fully

Compensator Type liquid
No. of axes dual (switchable on/off)
Setting range 3'47" (0.07 gon)
Setting accuracy
Types 1100/1500 1" (0.3 mgon)
Types 1700/1800 0.3" (0.1 mgon)

Sensitivity of bubble or of level Bull's-eye bubble 4/2 mm
Plate level none, electronic bubble resolution 2"

TS

Optical plummet	Location	tribrach
	Magnification (x)	2
Laser plummet	Location	In Alhidade, rotates with instrument
	Accuracy	max. rot. diameter laser point: ≤ 1 mm / 1.5 m
	Diameter of laser point	2.5 mm / 1.5 m

Battery	Type/voltage	NiCd/12V
	Capacity	1.1Ah
	Measurements	600 angles & distances (400 motorized)
	Location	in standard
	Power supply	The voltage must range from 10 to 16 V= (DC) when using external power cables

Keyboard and display	Position	both faces (1100/1500 series with face 2 as option)
	Alphanumeric support	ASCII and codelists
	Languages supported	IBM standard and others
	Type of display	LCD
	Size	8 x 35 (lines & characters)
	Graphics capability	Yes
	On-line help, messages	Yes

Weight	Instrument	
	TC/TCM/TCA1100	6.1/6.3/6.8 kg (13.5/13.9/15.1 lbs)
	TC/TCM/TCA1700/1800	6.4/6.7/7.2 kg (14.2/14.6/15.8 lbs)
	TC/TCA2003	6.9/7.5 kg (15.3/16.6 lbs)

	Tribrach	0.9kg (2lbs)
	On-board battery	0.3kg (0.7lbs)
Durability	Temperature range:	
	Measuring	-20° to +50° C (-4° to +122° F)
	Storage	-40° to +70° C (-40° to +158° F)
Other features	Programmability	Yes
	Alignment aid	as option
	Other	Motor & ATR1 option, reflector tapes
Automatic corrections	Line-of-sight error	Yes
	Vertical-index error	Yes
	Tilting-axis error	Yes (Type 1100/1500: No)
	Standing-axis tilt	Yes
	Earth curvature	Yes
	Refraction	Yes
	Circle eccentricity	Yes (Type 1100/1500: No)
Recording	RS232 interface	Yes
	Internal memory	Yes
	for programs	Yes
	Capacity	3MB
	Plug-in data memory	PCMCIA card
	for data	Yes
	Capacity	0.5, 2, 4 MB
	Number of data blocks	from 4500 - 36000
Drives	Tangent screws	
	Number Hz/V	2 Hz, 1 V
	Movement	single, fine (endless TCM/A)
	Other	
	TCM	motorized
	TCA	target recognition

**Technical specifications
of the Automatic Target
Recognition ATR1**

Positioning accuracy
(standard prism)

Standard measurement		
TCA1100	up to 200 m > 200 m	2 mm *
TCA1800	up to 400 m > 400 m	2 mm *
Precision measurement		
TCA1800	up to 200 m > 200 m	1 mm *
TCA2003	up to 200 m > 400 m	1 mm *

* according to angle measurement accuracy

Range
(under average conditions)

	Standard prism	360° reflector
ATR1 mode	1000 m/3300ft	500 m/1650ft
LOCK mode	500 m/1650ft	350 m/1150ft

Minimum	ATR1	5 m/16.4ft
	LOCK	20m/65ft

Recognition method	Video techniques	Yes
	EDM techniques	No
Prism use	Normal prisms	Yes
	Special active prisms	Not required
	Special 360° reflector	Yes
	Accuracy of 360° reflector	5 mm

Telescope features	Alignment	coaxial	
	Collimation accuracy	0.3" - 0.6" (0.1 - 0.2 mgon)	
Rotation and speed	Without tracking	at 20 m	1m/sec
		at 100 m	5m/sec
	During tracking	at 20 m	0.2 m/sec
		at 100 m	1m/sec

Searching	Lock-in time in active field of ATR1	< 1 sec
	Typical search time in telescopic field of view	2-4 sec
	Full scope of search	1° 33'
	Scope of search using remote control	18° (20gon)
	Interrupted viewing	Yes

Technical specifications of the EGL1 Guide Light

Working range	5m - 150m
Positioning range at 100 m	30 mm
Left/right indication	Yes

Application programs

(See user manual "TPS-System 1000 programs")

Coordinate display	Yes	selectable format
Orientation	Yes	with height transfer, calculates from up to 10 tie points
Stakeout	Yes	7 different methods of setting out
Resection	Yes	3 D
Free station	+	Up to 10 control points, with or without distance
Tie distance	Yes	with azimuth, height difference. In sequence or from central point
Remote height	+	
Area	+	Calculates perimeter, includes curved boundaries
Traverse	+	
Reference line	+	
Hidden point	+	
Sets of angles	+	
Road line	+	
COordinate GeOmetry	+	
RoadPlus	+	
FileEditor	+	
Monitoring	+/x	Automatic measuring
Programmable	+	Using GEOBASIC language. Does not require DOS on total station

Key :

Yes : included in delivery

+

: available as option

x

: additionally included in delivery of the TC2003/TCA2003

Atmospheric corrections

Atmospheric correction in ppm with °C, mb, H (metres)
at 60% relative humidity

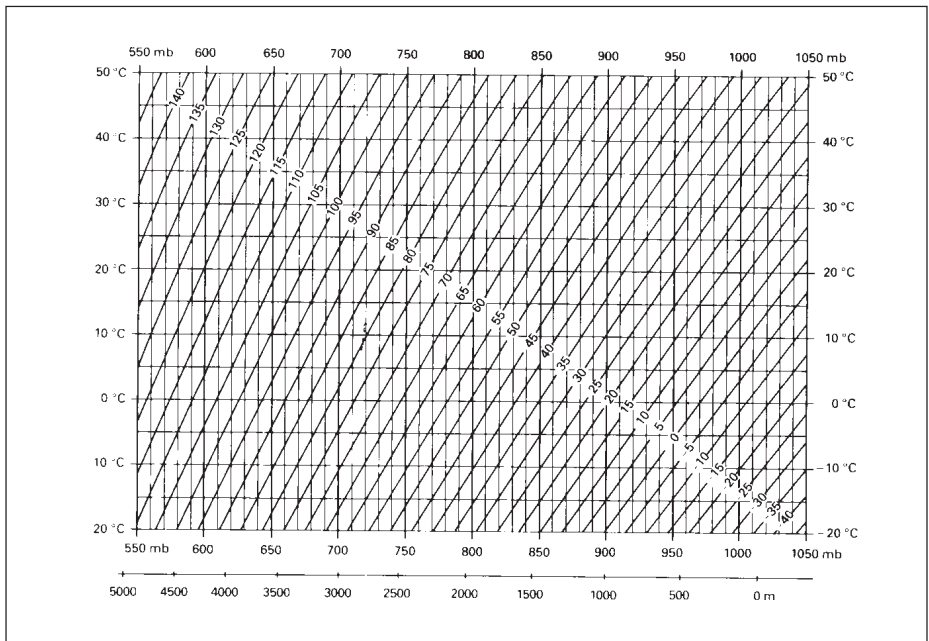

Atmospheric correction in ppm with °F, inch Hg, H (feet)
 at 60% relative humidity

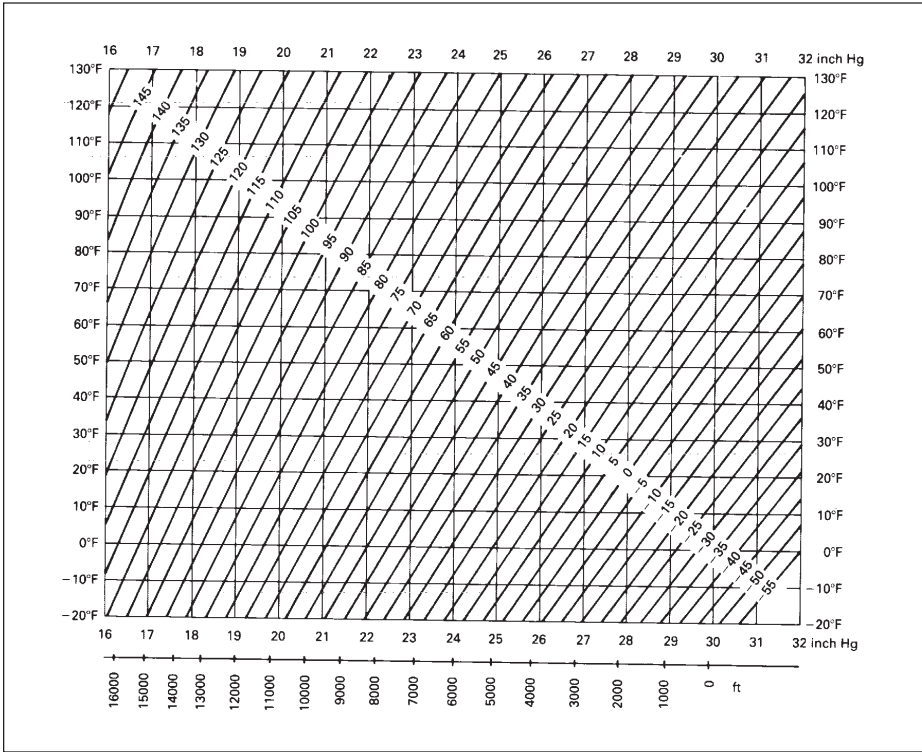

Index

Symbols

1-point orientation	88
360° prism	74
360° reflector	95, 167

A

Absolute angle values	170
Accessories	138
Accuracy of the prism position	153
Additional information	124
Additional lens	138
Adverse uses	220
aF.. - Additional functions	129
ALL	64
Allocation of keys	166
Allow data editing	106
Angle [Units]	123
Angle measurement	240
Application programs	246
Applications software	37
Area	246
Atm. press [Units]	123
Atmospheric correction	76, 247
ATR1	143, 219, 229
ATR1 and angle-measurement accuracy	153
ATR1 collimation	191
ATR1 mode	146
ATR1 resolution mode	152
Auto OFF	137
Auto-start configuration	110
Automatic target recognition	129, 143, 219
Average	131

B

Battery	242
Battery chargers	203
Battery charging	203
Battery display	53
Beep / Hz-Sector	135
Block concept	206
Block number	214

Brightness of EGL1 guide light	126
Brightness of the display	126
Brightness of the reticle illumination	126
Bull's eye bubble	196

C		
	Cables	202
	Care and transport	201
	CAUTION	4
	CCD	144
	Central meridian	77
	Centre of the prism	144
	Character field	46
	Charging battery	23
	Checking and adjusting	175
	Circular prism	73
	Class 1 laser	229
	Class 1 LED	228, 231
	Class 2 laser	233
	Cleaning and drying	202
	Code block	206, 207
	Code developer	124
	Code functions	124
	Code information	124
	Combined error determination	191
	Compass	168
	Compensator	132, 177, 241
	Complete list of display and recording parameters	119
	Configuration	102
	Contrast of the display	126
	Control keys	58
	Controlled data search	85

D		
	DANGER	4
	Data file	82
	Data flow	38
	Data format	205
	Data management	90
	Define functionality	105
	Deleting data	91
	Direct data search	84
	Display	42, 242
	Display template	118
	DIST	64

Distance [decimal places]	122
Distance [units]	122
Distance corrections (ppm)	76
Distance measurement	240
Drives	243
Durability	243

E

Edit data	92
EDM	33, 228
EDM measuring program	131
EDM selection	142
EDM test	134
EGL1 126, 143, 168, 171, 173, 219, 224, 231,	245
Electromagnetic acceptability	237
Electronic bubble	32, 128
Elements of measurement	66
Elev. angle %	136
Elev. angle +/-	136
Enable user configuration	106
Enter keys	58
Entering coordinates	91
Eyepiece laser diode	127
Eyepiece prism	138

F

Face definition	123
Fast measurement	131
Files	130
Fixed keys	57
Fogging of prisms	202
Follow a moving prism	148
Format a memory card	100
Format with 8 or 16 characters	205
Free station	246
Function keys	56, 166

G

GEOBASIC	246
GeoCOM	99
Geometrical correction	75, 77
Geometrical ppm	77
GPH1	25, 94
GPH1A	24, 73, 93

GPH1Z/GRZ3	93
GRZ4	95, 167
GSI command	40
GSI data format	215
Guide light	126, 143, 168, 171, 173, 219, 224, 231, 245

H	
Hazards of use	222
Heading	52
Heatable display	127
Height above the reference datum	77
HELP	32
Hidden point	246
Hz / V	170
Hz-corrections	132
Hz-system	123
Hz0	83

I	
Illumination	126
Import function	84
Import point data	84
Important paragraphs	4
Incrementing point numbers	72
Index error	177
Info	124
Input data	39
Input/output dialog	44
Insert mode	48
Installing a distancer	33
Instrument configuration	88
Instrument errors	175
Instrument identification	109
Integrated distancer	228
Intended use of instrument	219
Interface parameters (GeoCOM)	108
Interface parameters (GSI)	107
Interruptions to viewing	166

J	
Joystick	171

<hr/>		
K	Keyboard	42, 242
	Keystroke beep	135
<hr/>		
L	L.INT-Mode	150
	Language	122
	Laser classification	228
	Laser plummet	199, 233, 242
	Laser plummet in instrument	29
	Laser plummet ON/OFF	126
	Laser pointer	126
	Last point stored	172
	Limits of use	221
	Line of sight	184
	List field	50
	LOCK	167
	LOCK interrupt	150
	Lock interruption	172
	LOCK mode	129, 148
	Long distances	97
	Longitudinal and transverse axes (l, t)	177
	Longitudinal and transverse compensator-index error	179
	<hr/>	
M	Main menu	62
	Manual distance entry	79
	Measurement & recording	64
	Measurement block	206, 207
	Measurement file	82
	Measurement frequency	134
	Measuring distances and angles	35
	Measuring distances and angles separately	68
	Measuring distances and angles together	67
	Memory concept	38
	Menu tree	59
<hr/>		
N	Numeric field	49
<hr/>		
O	Offset between crosshair and prism centre	144
	Offset correction	73, 142
	On-line mode	99

ON/OFF	141
Operating concept	41
Optical plummet	197, 242
Output data	39

P	
Password	111, 122
PCMCIA card	202, 243
Placeholder	87
Plugs	202
Plumb-bob	197
Positioning accuracy	244
Power off	137
ppm	76
ppm values	75
Precision measurement	131
Preparing T- and TM - Versions	23
Preparing TC, TCM and TCA - version	25
Prism constant	97
Prism for attachable EDM	93
Prism for incorporated EDM	94
Prism type	75
Program-selection dialog	43
Programmable	246
Projection distortions	75

R	
Radio modems	162
Range	244
Rapid tracking	131
REC	64
Recording	243
Recording station data	83
Recording template	116
Reduction of the range	157
Refraction coefficient	75, 78
Refraction correction	78
Relative angle values	170
Remarks	71
Remote height	246
Remote-control mode	101, 107
Remote-Controlled Surveying	161
Responsibilities	221
Retro tape	74, 96
Rotation and speed	245

S

Safety directions	219
Scale correction	77
Searching	244
Sector beep	135
Sensitivity of bubble or level	241
Set and define prisms	73
Setting and entering Hz direction	83
Setting up the instrument	26
Show all menus and buttons	105
Show full ppm definition	105
Signal strength	134
Sleep	137
Sleep after	137
Software support	5
Standard measurement	131
Standard recording template	117
Start-up display	141
Station entry/setting	82
Status icons	53
Storage	202
Storage temperature limits	202
Structure of a block	207
Structure of a word	208
Supplementary information entered	71
System date and time	104
System password	111
System protection	111
System software	37

T

T - Version	17
TARGET	70
Target eccentricity	80
Target functions	166
Target-point data	70
TARGET	64
TC - Version	19
TCA - Version	21
TCM - Version	20
Technical specifications	240
Telescope	241
Telescope features	245
Temperature [units]	123
Temperature range	243
Terminator	208

The GeoCOM command	40
Tie distance	246
Tilting axis	188
Time	52
TM - Version	18
Topological data	71
Tracking	131
Transport	201
Tribrach with optical plummet	26
Tribrach without optical plummet	28
Tripod	195
Two-value field	52

U		
	Unfavourable atmospheric conditions	157
	Units of measurement	215
	Unpacking	22
	User configurations	113, 130
	User parameters	121
	User setting	82
	User template	122

V		
	V-angle display	136
	V-index error	180
	Version number	103
	View data	92

W		
	WARNING	4
	Weight	242
	Wild cards	87
	WORD-INDEX TABLE	209
	Workbench	37

Z		
	Zenith angle	136

***Leica Geosystems AG,
Heerbrugg, Switzerland
has been certified as being
equipped with a quality
system which meets the
International Standard of
Quality Management and
Quality Systems
(ISO standard 9001)***



***Total Quality Management-
Our commitment to total
customer satisfaction***

***Ask your local Leica agent for
more information about our
TQM program***

Leica

*Leica Geosystems AG
Geodesy
CH-9435 Heerbrugg
(Switzerland)*

Phone + 41 71 727 31 31

Fax + 41 71 727 46 73

www.leica.com

664901-2.3.1en

Printed in Switzerland - Copyright Leica Geosystems AG,
Heerbrugg, Switzerland 1998
Translation of original text (664901-2.3.1de)